

Canon

Zoemini S



Instant Camera Printer
User Manual

CONTENTS

SAFETY INFORMATION	P3
OVERVIEW	P4
Supplied Items	
Product Features	
SETUP	P5-8
Charge	
Load Paper	
External Memory	
OPERATION	P9-15
Power ON/OFF	
Taking A Photo	
Viewfinder	
Selfie Mirror	
Flash and Fill Light	
Aspect Ratio	
Printing and Reprint	
Remote Shooting	
Camera Voice	
LED Indicator	
Troubleshooting	
SPECIFICATIONS	P16
INSTALLING THE APP	P17-18
PAIRING MOBILE DEVICE & INSTANT CAMERA PRINTER	P19-23
Android Pairing	
iOS Pairing	
Android Pairing (with NFC)	
USER INTERFACE	P24-33
Home Screen	
Main Menu	
Smartphone Camera	
Photo Gallery	
Printing Photos	
Editing Photos	
Using Tile Print	
Using Collage Print	
Sharing Photos	
Saving Photos	
Send to Mini Print App	

SAFETY INFORMATION

READ BEFORE USE

Please read the following instructions and safety precautions before using the device.

For regulatory and additional safety information, refer to the Regulation and Warranty Information sheet included in your package contents.

RMN: PP2001

Regulatory Model Identification Number is assigned for regulatory identification purpose.

WARNING

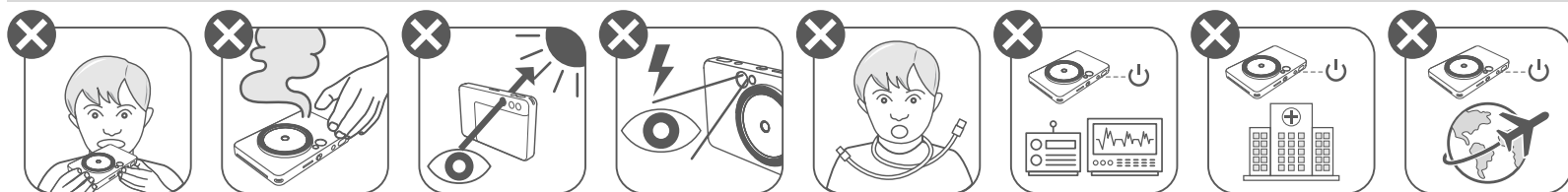

- Keep away from children and infants. Improper use of this product may cause suffocation or accident.
- Stop using the device immediately if it emits smoke or a strange smell, or otherwise behaves abnormally.
- Do not look at the sun or bright lights through the viewfinder or the lens. Blindness or vision problems could result.
- Do not fire the flash near the eyes. It may hurt the eyes.
- A strap wound around a child's neck may result in asphyxiation. If your product uses a power cord, mistakenly winding the cord around a child's neck may result in asphyxiation.
- Turn the device off in places where camera use is prohibited. The electromagnetic waves emitted by the camera may interfere with the operation of electronic instruments and other devices. Exercise adequate caution when using the product in places where use of electronic devices is restricted, such as inside airplanes and medical facilities.

CAUTION

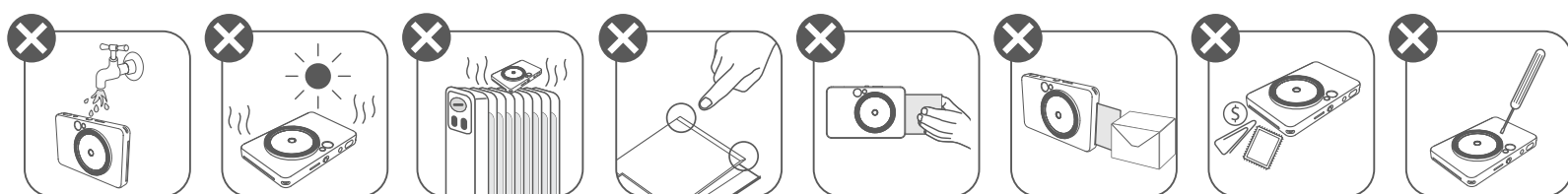

- When operating in extreme weather, the device might not print. Let the printer temperature adjust to the recommended operating temperature of 15° to 32°C, before attempting to print again.
- When charging, please charge the device at the recommended temperature of 15° to 32°C.
- Use a soft dry cloth to clean the device. Do not clean with a damp cloth or volatile liquids such as paint thinner.
- Keep the top cover closed to avoid dust and other particles from entering the inside of the device.
- If the device is not functioning properly, please contact the dealer you purchased this product from or Canon Service & Support at <https://www.canon-europe.com/support>
- Never expose the battery to high temperatures, direct heat, or dispose by incineration.
- Electromagnetic interference or electrostatic discharge may cause the device to malfunction or the memory to be lost or altered. Should this occur, use a pin, or similar item to press the [RESET] button at the bottom of the device.

OVERVIEW

SUPPLIED ITEMS

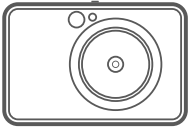

Instant Camera Printer



Quick Start Guide



Regulation and
Warranty
Information sheet

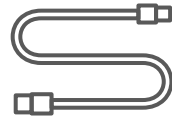

USB Cable



CANON ZINK™
Photo Paper
(10 sheets)



Wrist Strap

PRODUCT FEATURES

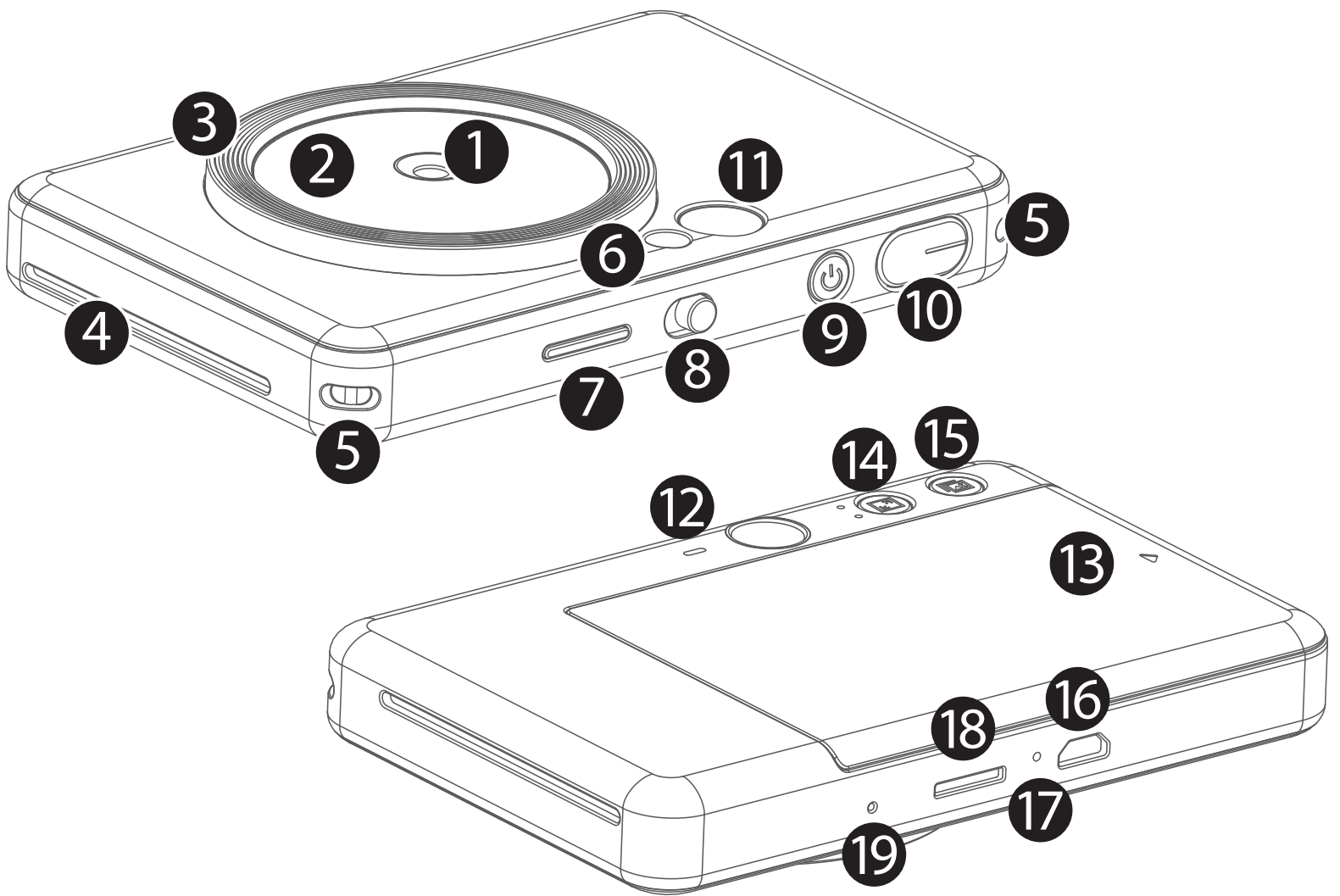

- 1 Camera Lens
- 2 Selfie Mirror
- 3 Fill Light (8 LEDs)
- 4 Print Output Slot
- 5 Strap Hole
- 6 Flash
- 7 Status LED
- 8 Slide Switch (Off/Auto/Fill Light)
- 9 Power Button
- 10 Shutter Button
- 11 Viewfinder
- 12 Speaker
- 13 Printer Cover
- 14 Aspect Ratio Button
- 15 Reprint Button
- 16 Micro USB Port
- 17 Charging Status LED
- 18 MicroSD Card Slot (up to 256GB)
- 19 Reset Button

* To reset the device, press with a pin

SETUP

CHARGING

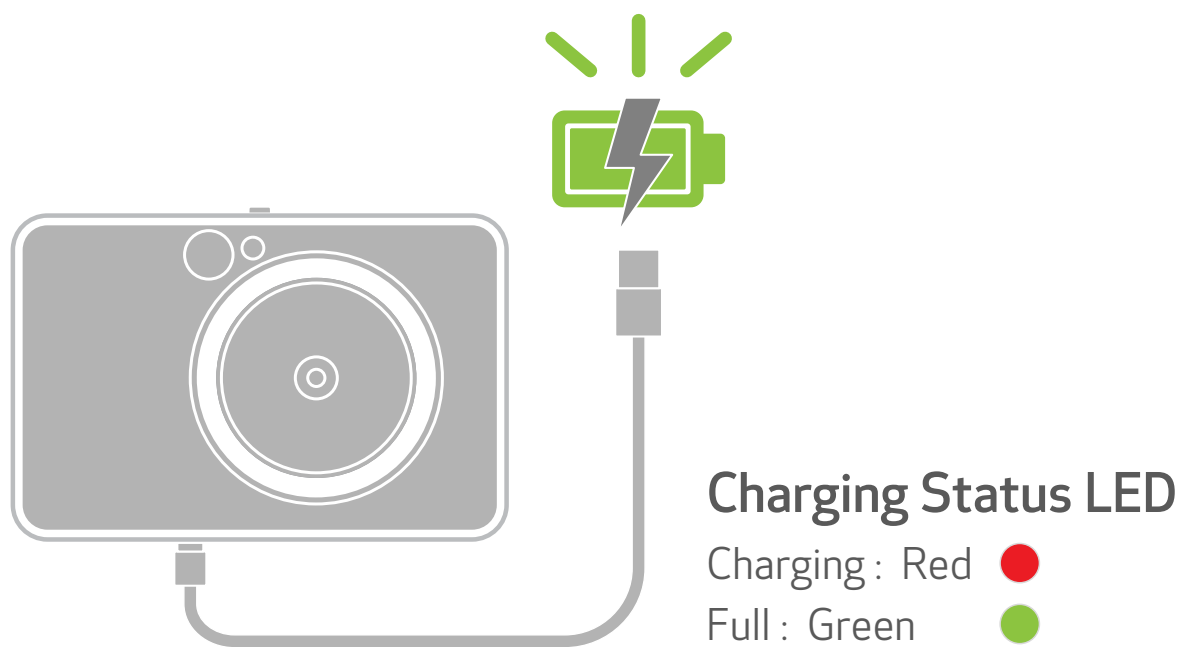

The device has a built-in battery. Please fully charge the device via the USB cable provided before using.

- 1 Insert the smaller end of the supplied USB cable into the device and other end into a chargeable USB adapter.
- 2 The charging LED light will turn red to indicate charging.
- 3 Once fully charged, the charging LED will turn green.
 - Operating time may vary depending on the battery status, operational status and environment conditions.

! NOTE

About USB Cable

HANDLE THE USB CABLE WITH CARE WHILE CHARGING

- Do not place any heavy objects on top of the cable.
- Do not place the USB cable near heat.
- Do not scratch, damage, twist or pull hard on the cable.
- Do not plug or unplug the cable with wet hands.
- Avoid too high/too low temperature or humid conditions.
- Please unplug the USB cable from power source after charging.
- Please use the supplied USB cable for charging.

LOAD PAPER

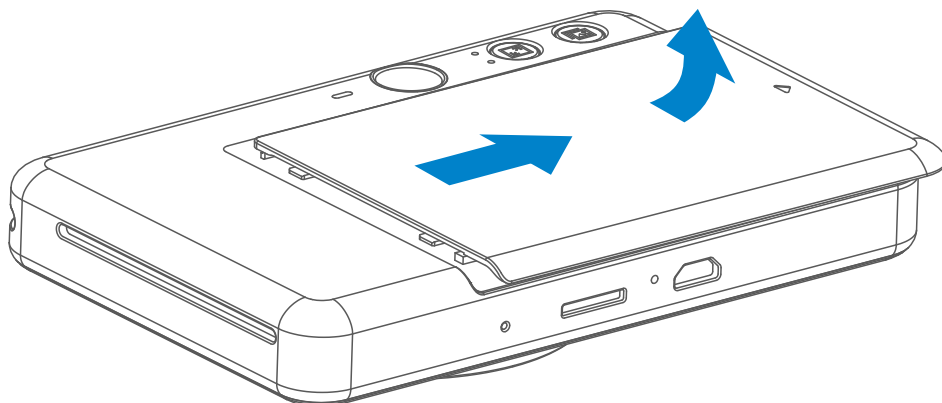

- 1 Remove the cover by sliding it forward in the direction of the arrow.

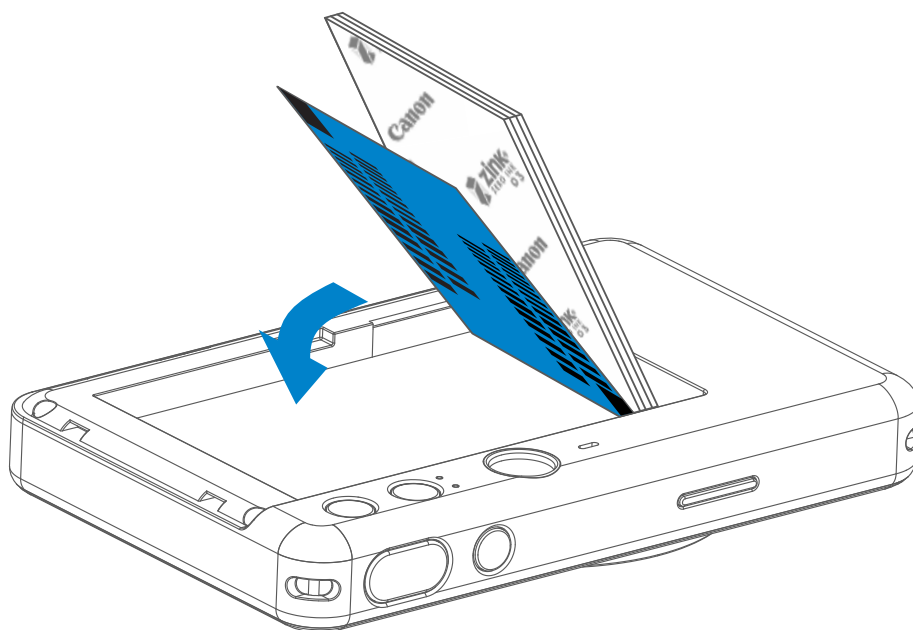

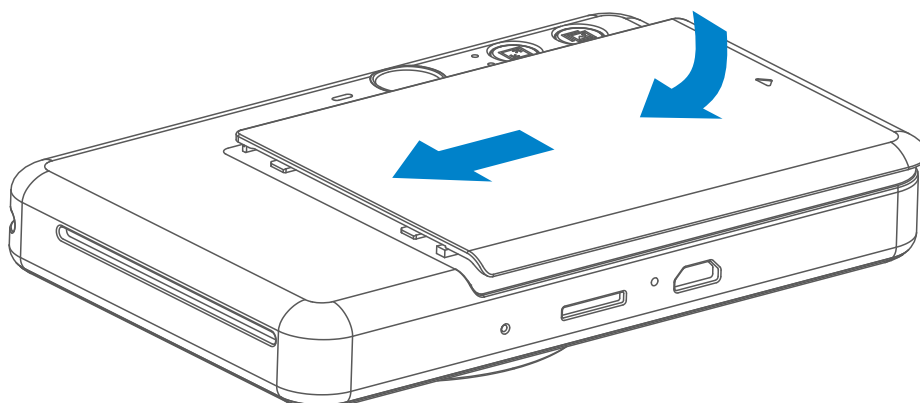

- 2 Open a single pouch of photo paper (10 sheets + blue SMART SHEET™).
- 3 Place all 10 photo paper sheets and the one SMART SHEET™ into the photo paper compartment.
 - Stack the photo paper on top of the blue SMART SHEET™, making sure the blue barcode and the photo paper logos are facing down.

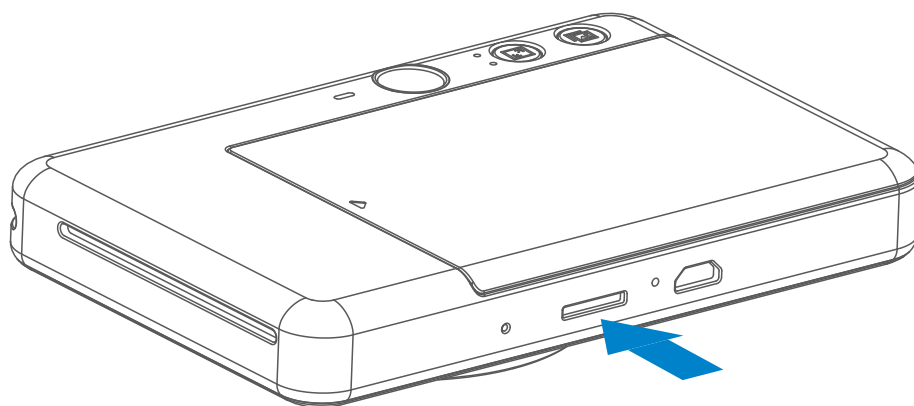

- 4 Place the top cover back onto the device. It should click into place when closed properly.
 - The blue SMART SHEET™ will be sent through the device automatically before the first print.

EXTERNAL MEMORY



 An external MicroSD card (up to 256 GB) is needed for saving captured photos. Only FAT16, FAT32 and exFAT format are supported.

PREPARING A MEMORY CARD

Use the following memory cards (sold separately)

- MicroSD memory cards *1
- MicroSDHC memory cards *1 *2
- MicroSDXC memory cards *1 *2

*1 Cards conforming to SD standards. However, not all memory cards have been verified to work with the camera.

*2 UHS-I memory cards are also supported.

INSTALL AND REMOVE THE MicroSD CARD

- Insert the MicroSD card into the slot at the bottom of the device. You will feel a slight click when the card is fully inserted .
- Push on the top of the card to release it. Gently pull to fully remove the card from the device.
- If there is an error on reading /writing to the MicroSD card, the FAIL sound will play once. Remove the MicroSD card and restart the device.
- Connect the device to a computer by USB cable. Double-click the external drive image when it appears on the computer to view and save the photos.

NOTE

MAINTAINING THE DEVICE

- Use and keep the device in the recommended environment of 15° to 32° C and 40-55% relative humidity.
- Keep your device firmware up-to-date. To check if your firmware needs to be upgraded, open the Canon Mini Print app, go to the Main Menu > Settings > Printers, select your device and enter to Product Info, then tap "Firmware Upgrade".
 - Make sure your mobile device has an internet connection before checking. If you need to upgrade the firmware, your printer must be charged to 50% or higher.
- Make sure you're using the latest Canon Mini Print app version. If your apps don't automatically update, go to the app store and check if you need to update.

NOTE

WHEN USING PHOTO PAPER



- Only load 10 ZINK™ photo paper sheets and 1 SMART SHEET™. Do not load more as it can result in paper jams or printing errors.
- For optimal print results, use ZINK™ photo paper for Canon Zoemini S.
 - You may purchase additional photo paper within the Canon Mini Print App by tapping “Buy Paper” in the main menu.
- If there is a paper jam, simply turn the printer OFF and ON to automatically clear the paper jam. Don't try to pull the paper out.
- While the device is printing, don't pull or tug on the photo paper.
- Handle photo paper carefully to avoid damage or bending.
- Keep the photo paper clean when loading. If photo paper is dirty or damaged, it may result in a paper jam or print error.
- Don't open a new pouch of photo paper until you are ready to load it into your device.
- Don't expose photo paper to direct sunlight or moisture.
- Don't leave your photo paper in an area where the temperature or humidity is out of the suggested conditions indicated on the pouch. It may reduce the quality of the printed photo.

ABOUT THE SMART SHEET™

- Each pouch of photo paper contains 10 sheets of photo paper and 1 blue SMART SHEET™.
- Load the SMART SHEET™ and photo paper from within the same pouch for optimal print quality. Each SMART SHEET™ is specifically tuned for the pouch of paper it is contained in.
- The SMART SHEET™ will be sent through the device automatically before the first print to clean the printer and optimize print quality for that specific paper pouch (10 sheets).
- Keep the SMART SHEET™ and only discard after you have printed all 10 sheets of photo paper in the pouch. If print quality is not as expected, you can reuse the SMART SHEET™ if the paper is still from the same pouch. Simply slide the SMART SHEET™ with its barcode-side down underneath the remaining photo paper.
- Using a SMART SHEET™ from another pouch may result in reduced print quality.

OPERATION

POWER ON/OFF

- 1 Press and hold the Power button  until the LED indicator light turns on.
- 2 When the LED indicator turns to a steady white, the device is ready to use.
- 3 Press and hold the Power button  to turn off the device.

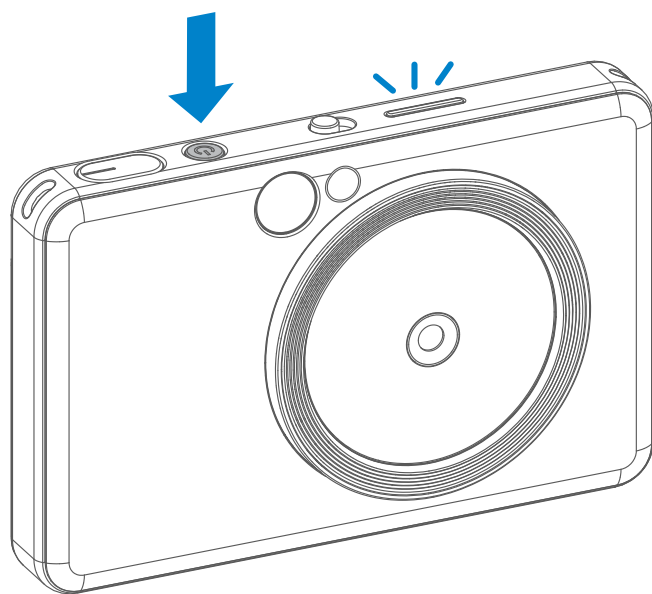

AUTO POWER OFF

- When the device is idle for about 3 minutes (default), it will automatically power off. The user can resume the device by pressing the Power button again.
- The user can change the time (3 minutes / 5 minutes / 10 minutes) in the App.

TAKING A PHOTO

- 1 Hold the device, confirm the desired composition of the image.
- 2 Press the Shutter button  to take a photo.
 - Half press for focus lock
 - Full press to take a photo

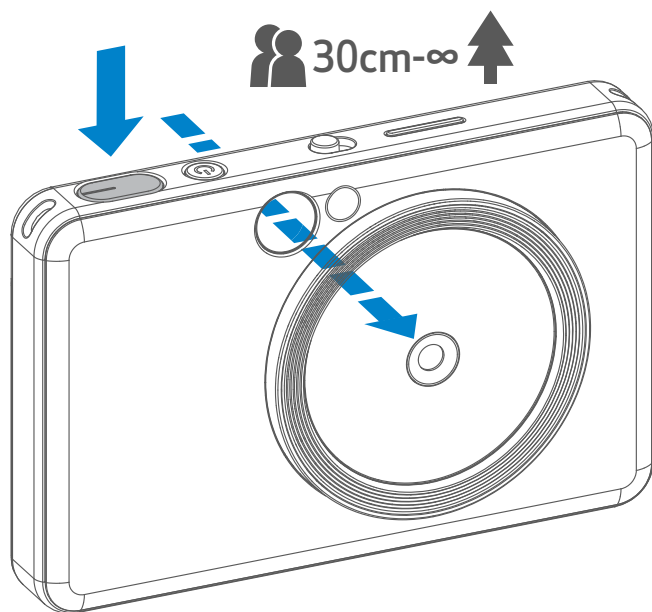

VIEWFINDER

Compose an image with the frame mark in the viewfinder.



2 x 3



Outer Frame Mark
for normal shooting
at 1m - ∞

2 x 2



2 X 2 Frame Mark
for normal shooting
at 1m - ∞

2 x 3



Inner Frame Mark
for close up shooting
at 30cm

SELFIE MIRROR

Compose an image with the frame mark in the Selfie Mirror.



2 x 3



Focusing distance
at 50cm

2 x 2



Focusing distance
at 50cm



FLASH AND FILL LIGHT

FLASH

When the device is powered on and flash  is set to AUTO, the camera will automatically trigger the flash if it is necessary for the lighting conditions.

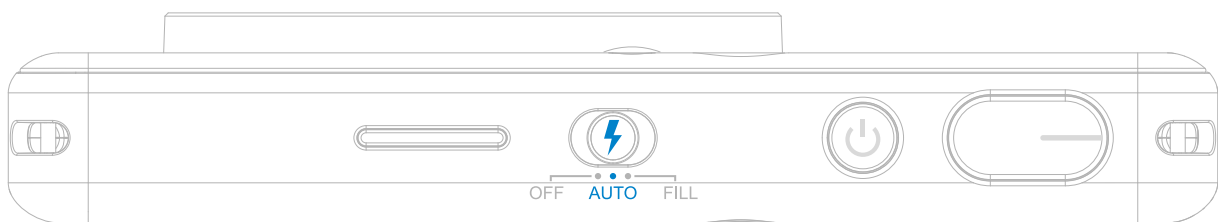

FILL LIGHT

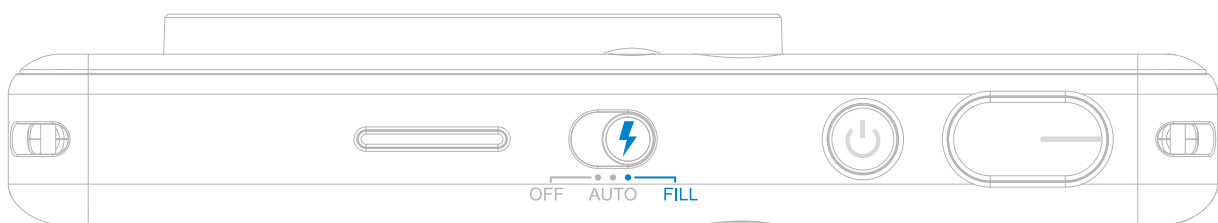

There are 8 LED Fill Lights built into the device around the lens to provide a soft light support when taking a photo.

If you are about to take a selfie in Fill Light mode, the 8 LED ring shape Fill Lights around the lens will give an uniform illumination on your face. It allows you to take a beautiful selfie, by minimizing the shadow and creating an uniform brightness across the entire photo.

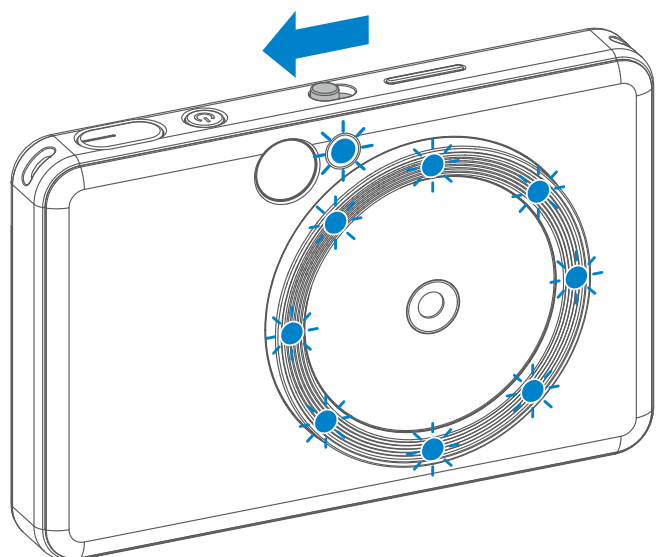

* Effective Fill Light Range: 30cm - 60cm

ASPECT RATIO

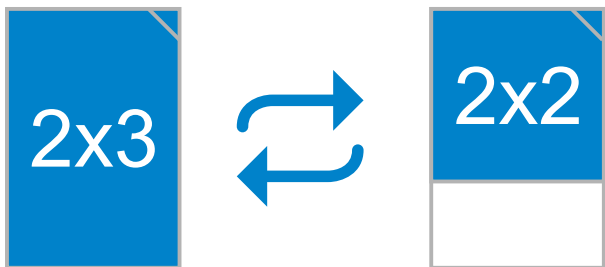

The user can choose between two aspect ratios, 2x3 and 2x2 with the Aspect ratio button .

Aspect ratio can be changed at any time before taking a photo.

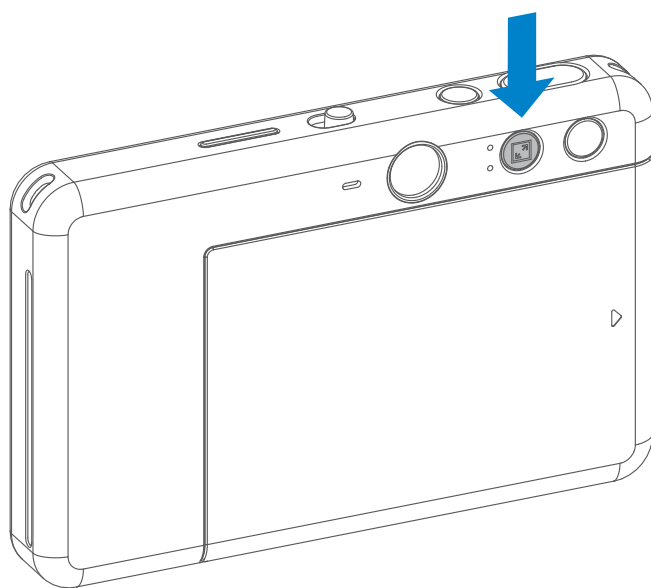

When the aspect ratio is 2x2, the blank area of the photo paper is different. It is based on how the device is being held.

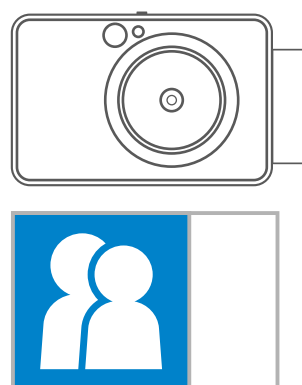
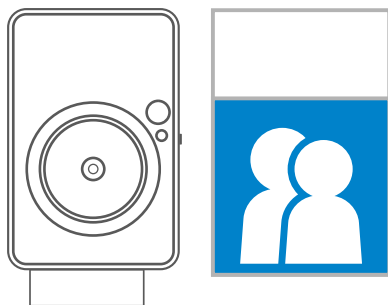
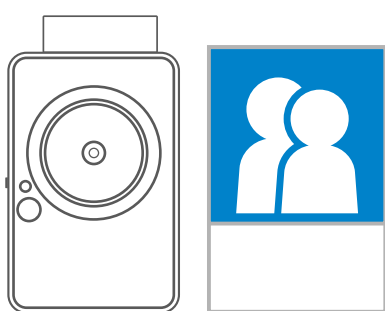

PRINTING AND REPRINT

PRINTING A PHOTO

- The photo will be printed out immediately after taking the photo.
- The device can hold up to 3 images at a time to print.
- The device can also print photos from your smartphone via the App.

REPRINT A PHOTO

When you have captured a photo and it is printed out, if you want to duplicate the same photo or distribute several pieces of the same photos in a party, you can just simply press the Reprint button  to reprint the last printed photo.

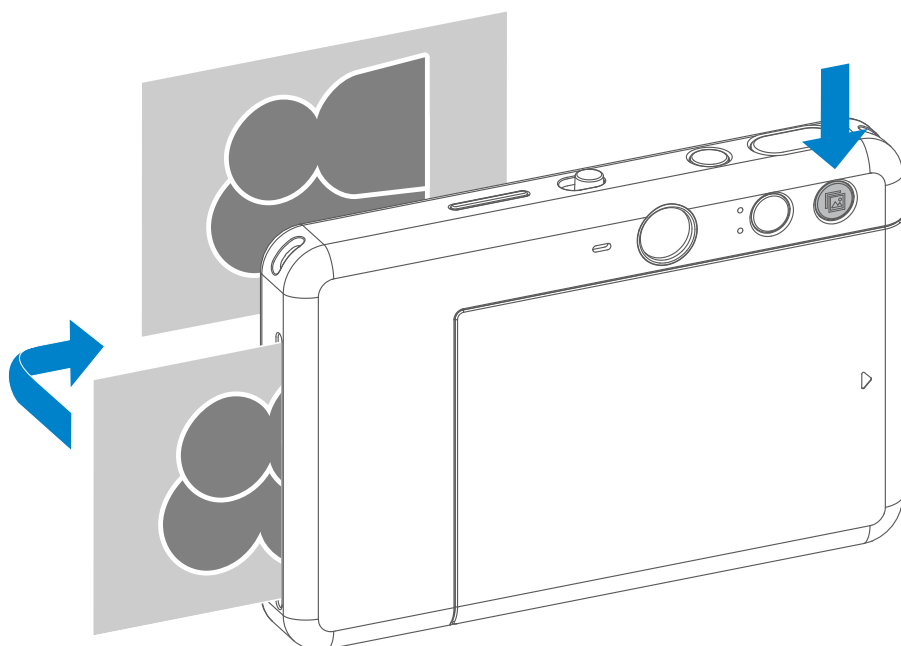



REMOTE SHOOTING

The user can remotely control the device through the App such as taking photos.

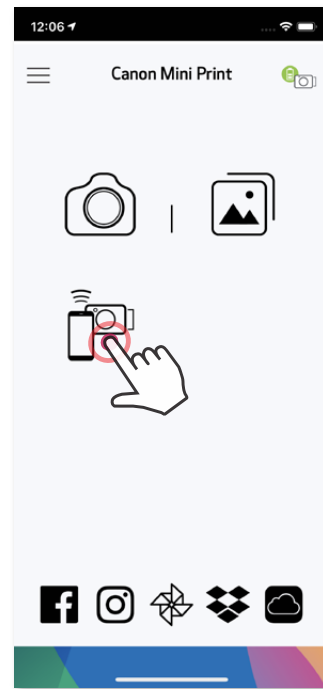
Press  on the App to enter the Remote Control Page.



TIMER

Press  to capture a photo instantly. Press  and select 3 seconds/ 5 seconds/ 10 seconds timer (default: OFF), press  to begin the countdown.

- The Timer LED light around the selfie mirror will alert you if the timer is enabled.

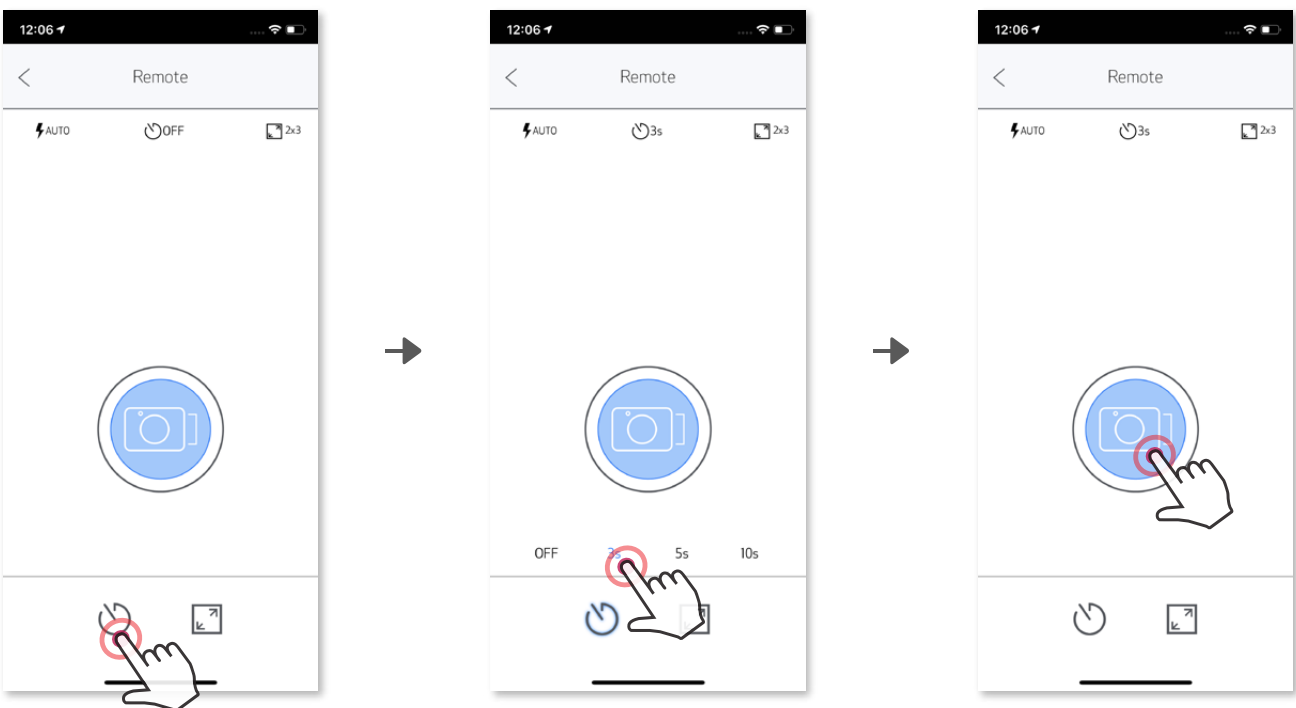

ASPECT RATIO

Press  to choose between two aspect ratios (2x3 and 2x2).

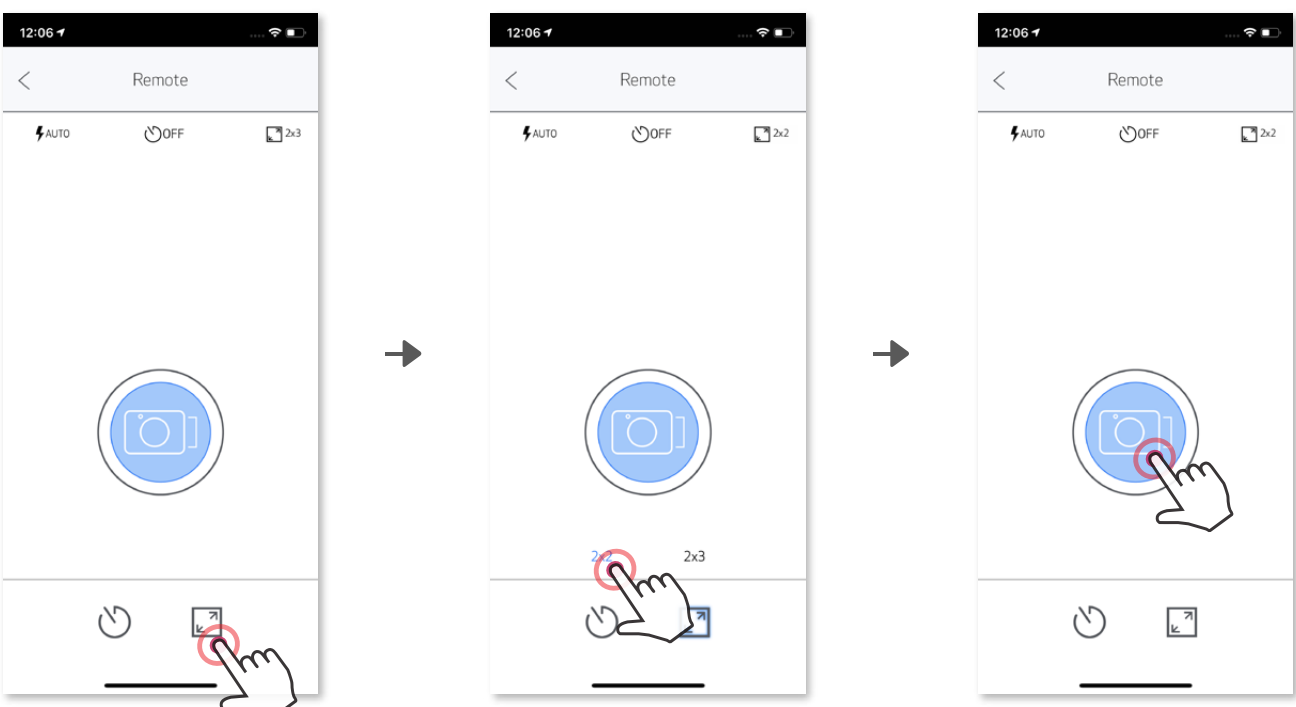



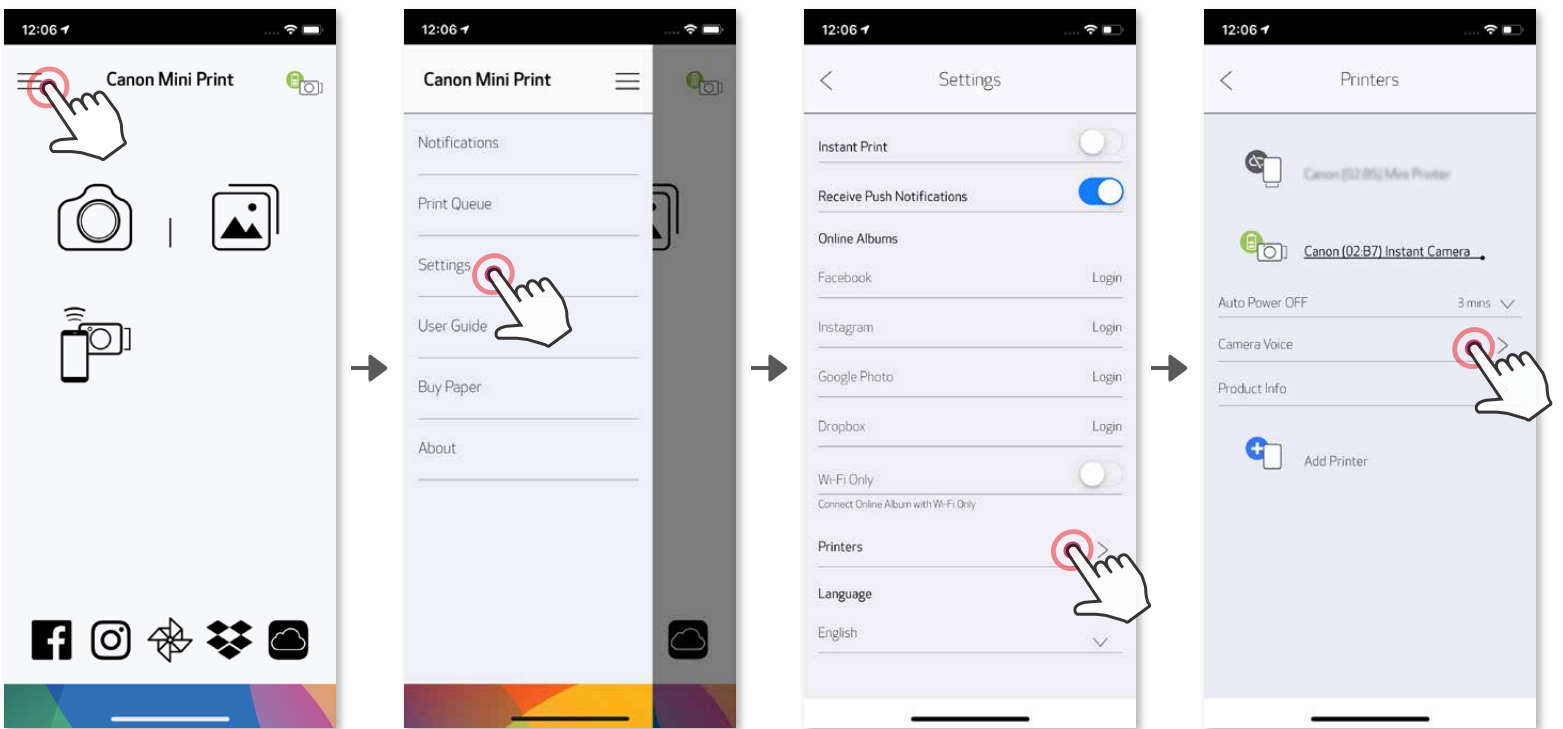

CAMERA VOICE

When the camera is connected with a mobile device, the user can customize the sound effects for "Power On", "Power Off", and "Shutter". User can record 3 sound files (maximum 4 seconds) for each camera voice effect through the App.







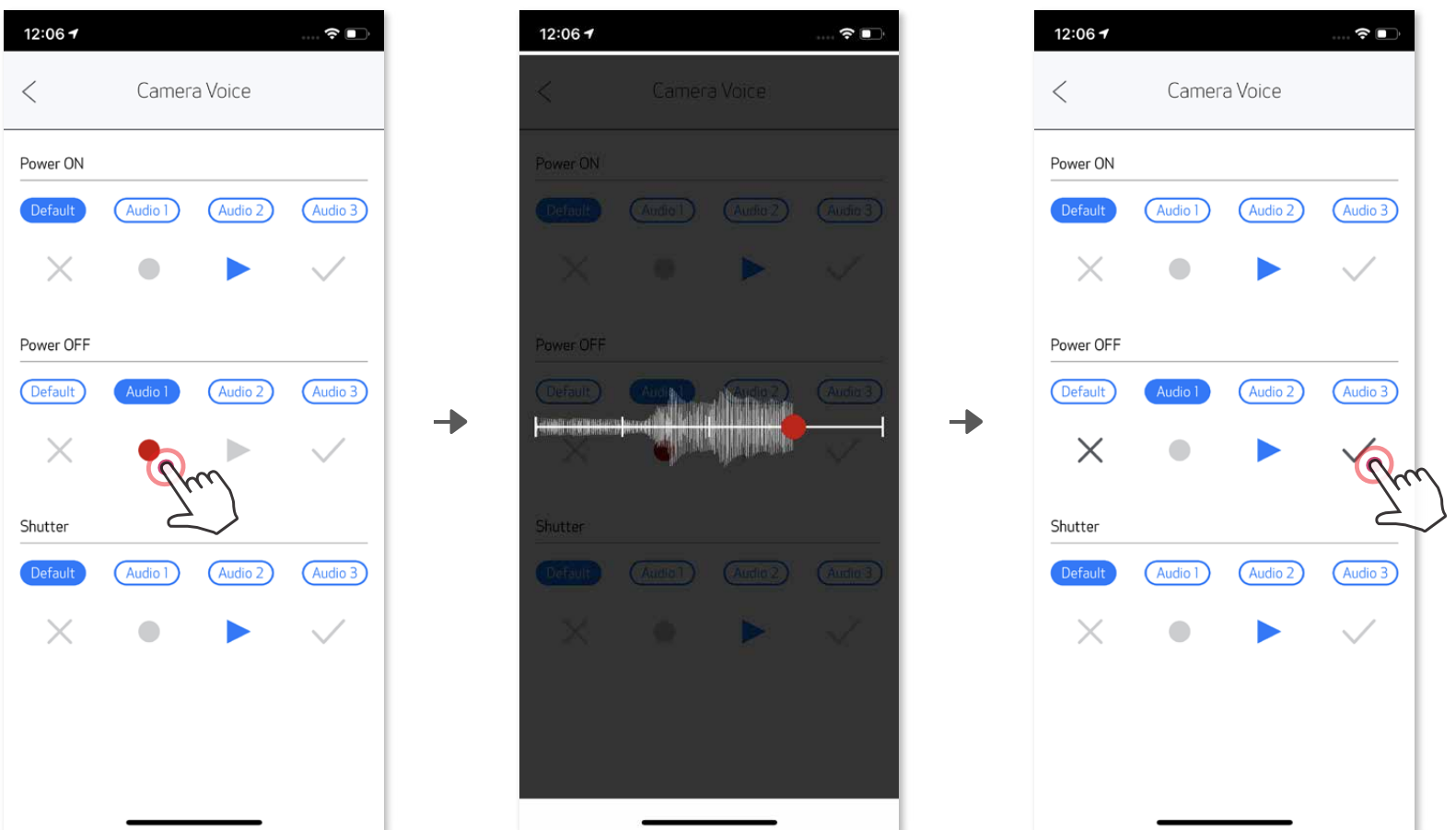





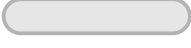

Tap  in the main menu, go to Settings > Printers, select your device and tap on "Camera Voice".



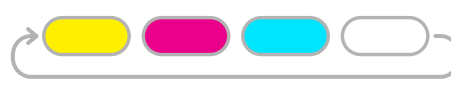

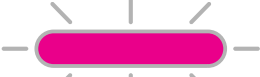

To start a recording, tap on the desired sound file icon e.g.  , and then  . Press  for audio playback, and  to save and apply the sound effect to the camera.





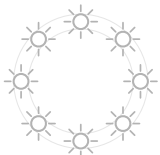

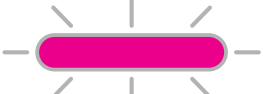

LED INDICATOR

Status	Operation / Situation	LED Indicator
Power On	Press and hold the Power Button	 >  Blue White
Standby	After the device is powered on	 White
Power Off	Press and hold the Power Button	 Off
SMART SHEET™ Error	When the device detects wrong SMART SHEET™ is inserted, or other SMART SHEET™ error	 Blue
Processing SMART SHEET™	When the device is printing out SMART SHEET™	 White
No Paper	When the device has no paper, the device will not allow for taking a photo	 Red
Paper Jam/ Cover Open	When there is a paper jam or the printer cover is opened	 Red
Get Ready for Printing	Preparing for printing	 White
Printing Photo	When the device is printing a photo	 Yellow > Magenta > Cyan > White (Looping)
MS Mode (Mass Storage Mode)	Device is connected to a computer	 Magenta
MicroSD Card Error	Cannot write data into MicroSD Card	 Magenta
Temperature Too High	When the device temperature is too high	 Red (Until temperature returns to normal)
Temperature Too Low	When the device temperature is too low	 Cyan (Until temperature returns to normal)
Printer Head Cooling	Checking the printer head temperature and letting it cool down before printing	 Cyan

Low Battery	When battery level is down to 20%	 White > Red (Looping)
Very Low Battery	When battery level is very low	 Red > White (Looping)
Firmware Updating	When the device is updating firmware	 White
2 x 3 Aspect Ratio	When 2x3 aspect ratio is selected, 8 LEDs in the fill light will flash once	
2 x 2 Aspect Ratio	When 2x2 aspect ratio is selected, 4 LEDs in the fill light will flash once	

TROUBLESHOOTING

Status	LED Indication	Actions
MicroSD Card Error	 Magenta	<ul style="list-style-type: none"> • Check if the MicroSD card is inserted properly • Check if the MicroSD card is full • Check if the MicroSD card is corrupted • Check if the MicroSD card is compatible
Paper Feeding Failed	 Red	<ul style="list-style-type: none"> • Open the paper compartment cover to check if Canon ZINK™ photo paper is inserted
Paper Jam	 Red	<ul style="list-style-type: none"> • Power off and on the device, the photo paper will be fed out automatically
No Paper	 Red	<ul style="list-style-type: none"> • Reload Canon ZINK™ photo paper into the device
Printer Cover is not closed properly	 Red	<ul style="list-style-type: none"> • Close the printer cover properly
Overheat	 Red	<ul style="list-style-type: none"> • Wait until the device temperature returns to normal, the device will resume working again
Connection	N/A	<ul style="list-style-type: none"> • Make sure the smartphone Bluetooth® connection is properly set up. • Make sure selection of device on the App is correct • Make sure smartphone OS is compatible and up to date
Remote Control Failed	N/A	<ul style="list-style-type: none"> • Make sure the device is connected with the App • Make sure the App and firmware are up to date
Customized Sound Failed	N/A	<ul style="list-style-type: none"> • Make sure the device is connected with the App • Make sure the App and firmware are up to date
Device does not Work	N/A	<ul style="list-style-type: none"> • Make sure the battery level is not too low. If it is, recharge the device
Take a Photo	N/A	<ul style="list-style-type: none"> • Make sure the device firmware is up to date • Make sure print queue buffer is available • Make sure device has Canon ZINK™ photo paper

SPECIFICATIONS

Printing Technology	ZINK™
Printing Resolution	314 x 600 dpi (dots per inch)
Printing Speed	Approximately 50 seconds - Motor starts and stops, at room temperature 25° C
Photo Aspect Ratio	2" x 2" or 2" x 3"
Compatible Paper	Canon ZINK™ Photo Paper : ZP-2030-20 (20 sheets) ZP-2030-50 (50 sheets) 2" x 3" / Peel-and-Stick Back
Paper Capacity	Up to 10 sheets of ZINK™ photo paper + 1 SMART SHEET™
Photo Resolution	8MP
Focal Length	25.4 mm
Aperture	f 2.2
Focusing Range	30cm - ∞
Sensitivity	Auto (ISO 100 - 1600)
Flash	YES (Auto)
Flash Range	0.5m - 1.0m
Memory Card	MicroSD Card, up to 256GB
Power Source	Built-in Rechargeable Li-Polymer Battery 700mAh, 7.4V
Charging Speed	Approximately 120 minutes (Full Charge)
Power Adapter	Output Current : 1A (min) Voltage : 5V
Environmental Parameters	- Recommended Printing Operating, Charging, and Storage Temperature : 15° to 32° C - Recommended Printing Operating, Charging, and Storage Humidity : 40-55% RH - Operating Temperature : 5° to 40° C - Operating Humidity : < 70% RH
Automatic Power-off	3 minutes / 5 minutes / 10 minutes (selectable in-app)
Dimension	121mm (W) x 80.3mm (H) x 21.5mm (D)
Weight	188 g
Compatible OS (for Computer)	Windows 7 / 8 / 8.1 / 10 Mac OSX 10.10 - 10.14
Connectivity	Bluetooth® 4.0
Compatible OS	iOS 9.0 or above & Android 4.4 or above
Mobile Application	Canon Mini Print
Connection for Charging and Data Transfer	USB 2.0 (Micro USB)

Subject to change without notice

INSTALLING APP

OPTION ①

SEARCH FOR "Canon Mini Print" IN APP STORES

For Android™ - from Google Play™

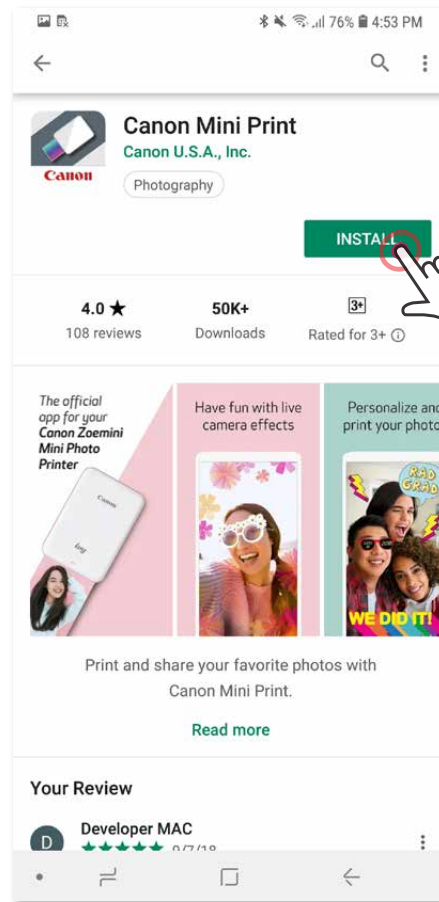
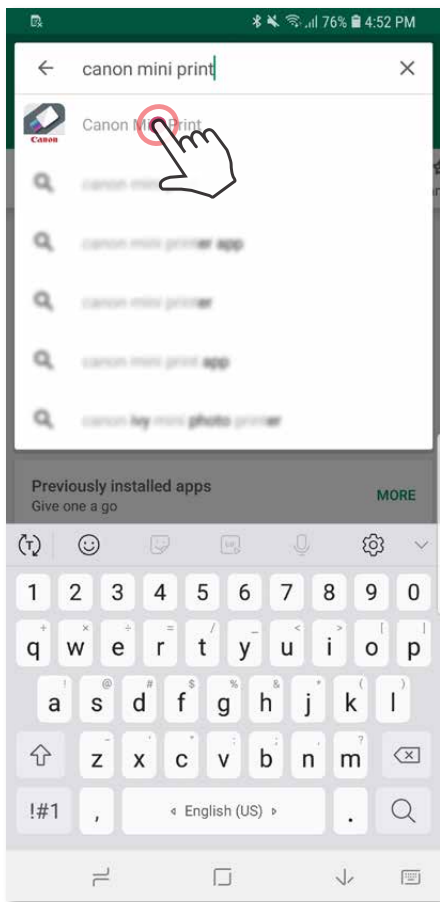

For iOS® - from the App Store®

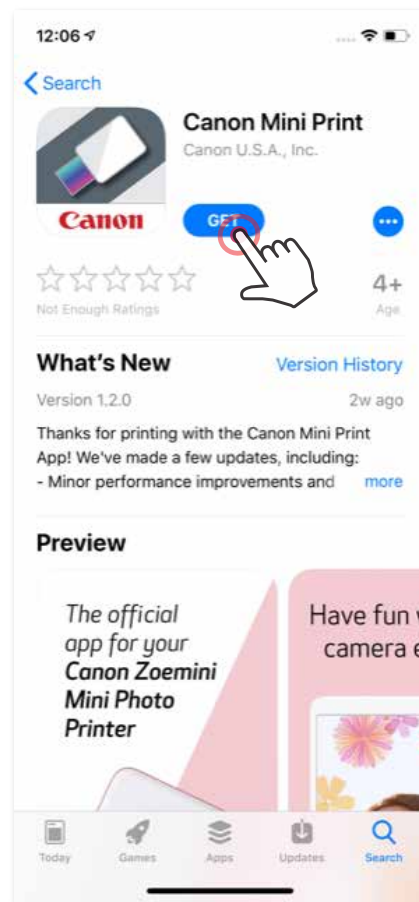
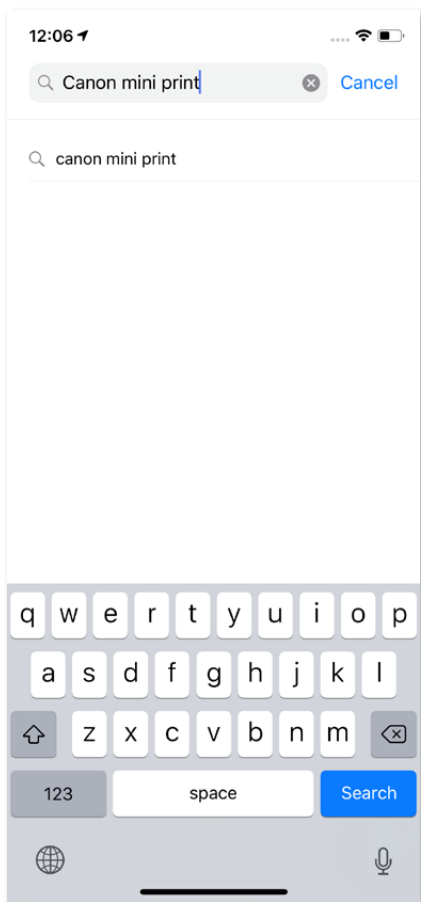

OPTION ②

USING QR CODE - SCAN THE QR CODE ON THE "Quick Start Guide"



For Android

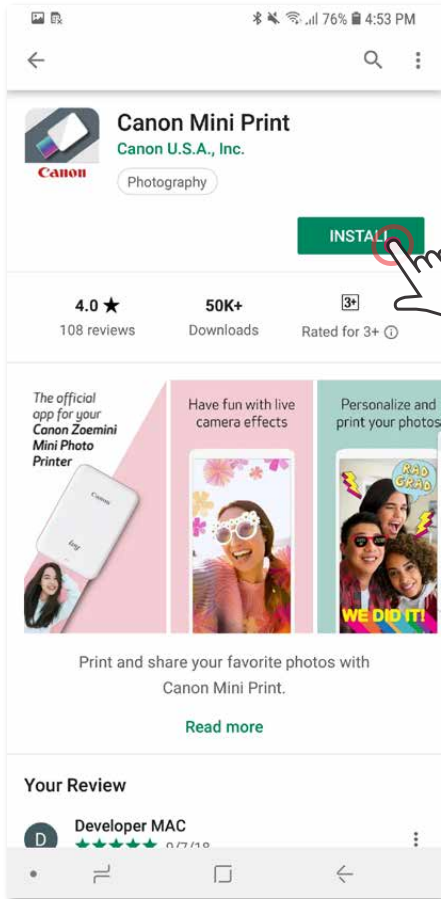

For iOS

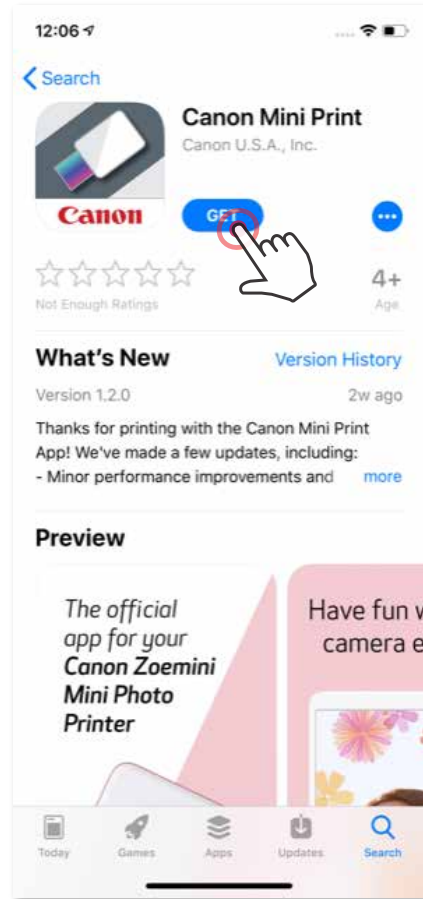

OPTION ③

In your device browser GO TO <https://app.canonminiprint.com/>

OPTION ④

USING NFC For Android ONLY

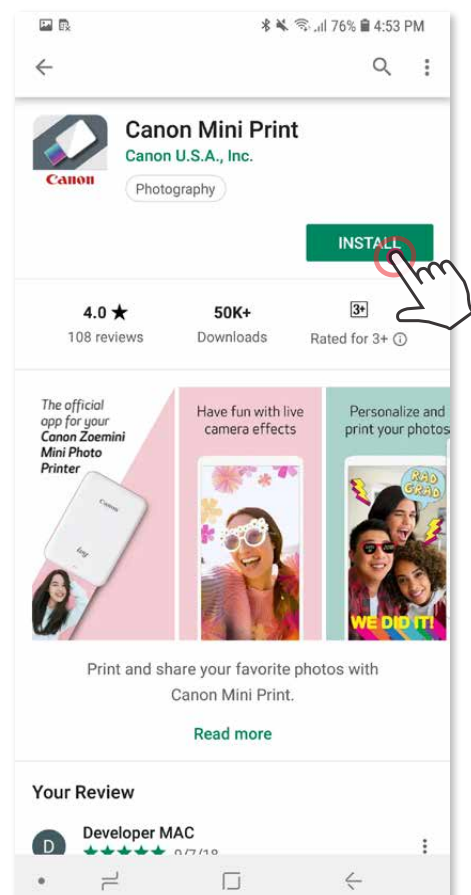
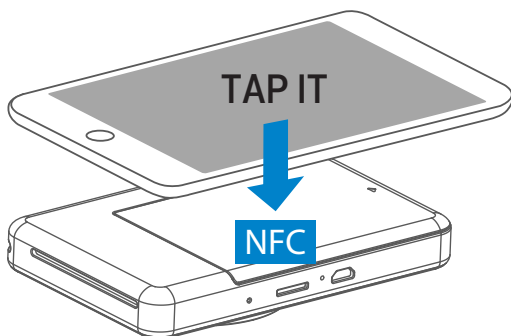

PAIRING MOBILE DEVICE & INSTANT CAMERA PRINTER

Android Pairing

- ① Turn on the printer by pressing and holding the Power button until the status LED light turns on.
- ② Open mobile device "Settings" to enable Bluetooth® and pair it with the printer.

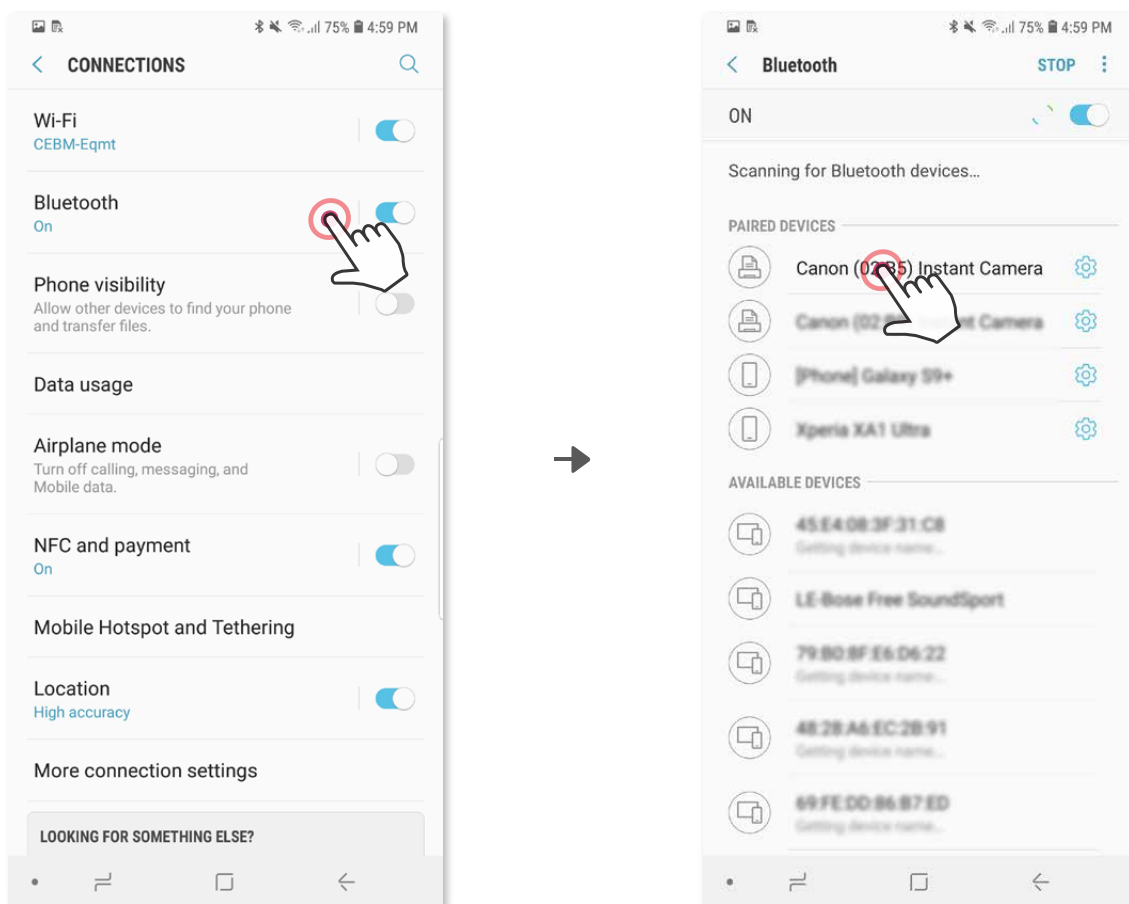

- ③ **OPTION A** - Add the printer to the app. Tap on the icon on the top right and choose your printer. The icon will change to indicate battery level when connected.

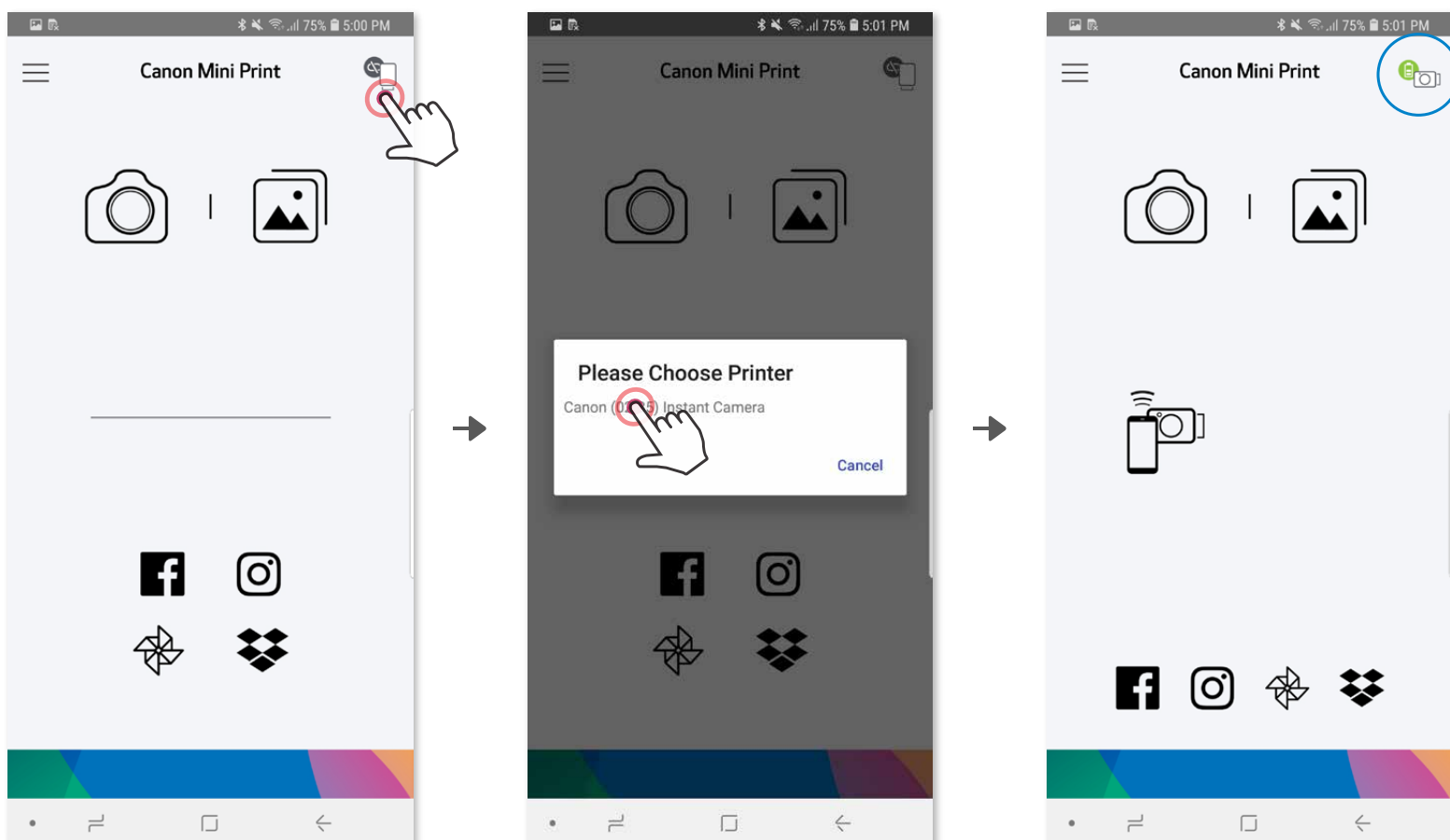

— OR —

- ③ **OPTION B** - Add the printer to the app. Go to "Settings" in the main menu, choose "Printers", then tap "Add Printer" and select your printer. Your printer will appear in the "Printers" list and the icon will change to indicate battery level when connected.

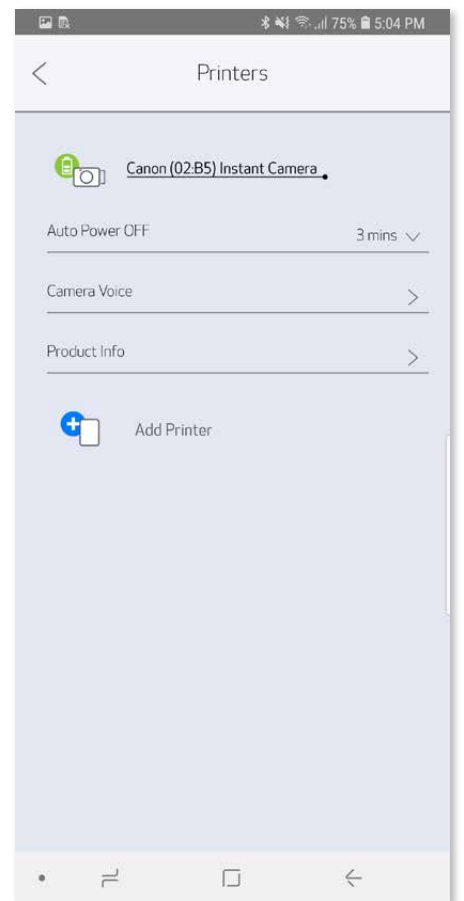
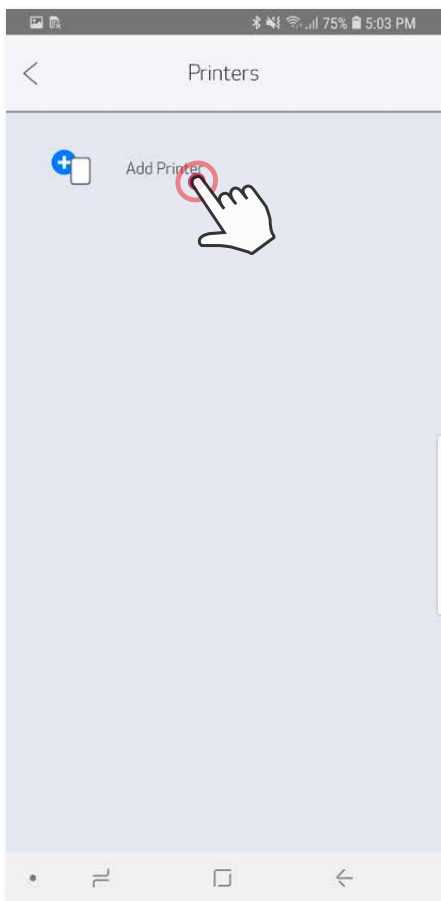
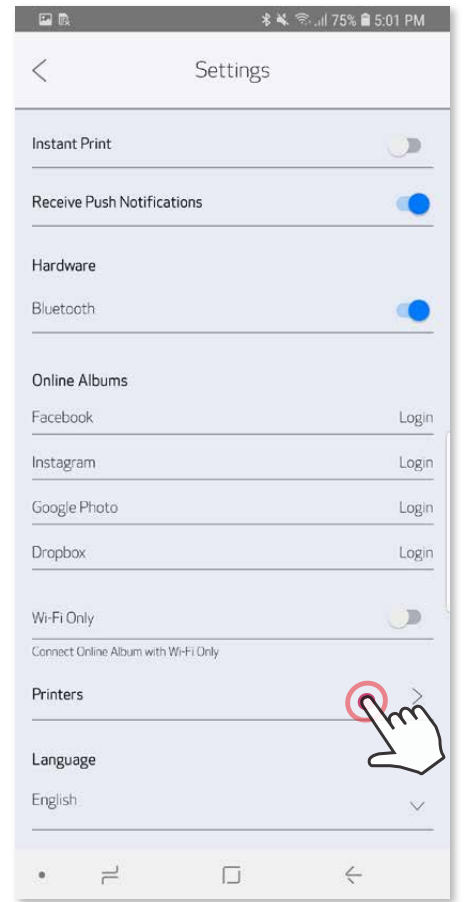
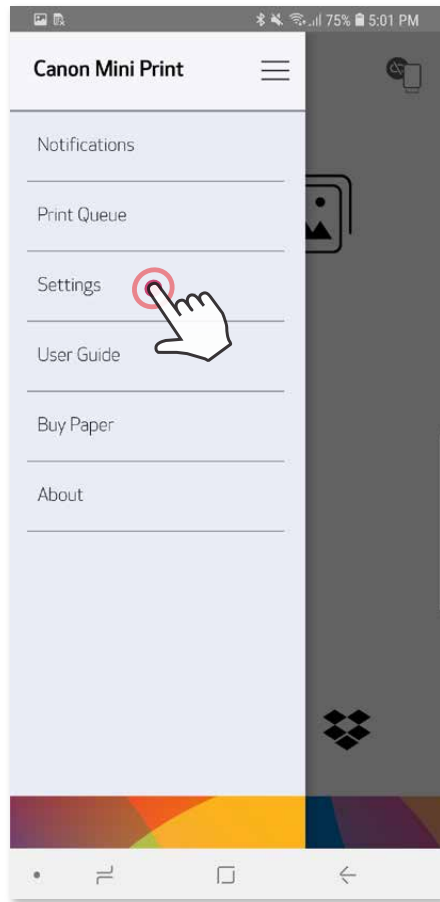
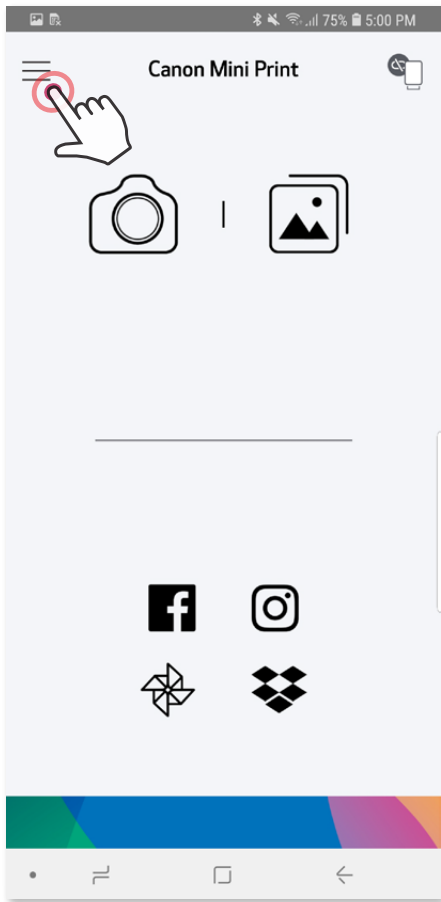

iOS Pairing

- ① Turn on the printer by pressing and holding the Power button until the status LED light turns on.
- ② Open mobile device "Settings" to enable Bluetooth® and pair it with the printer.

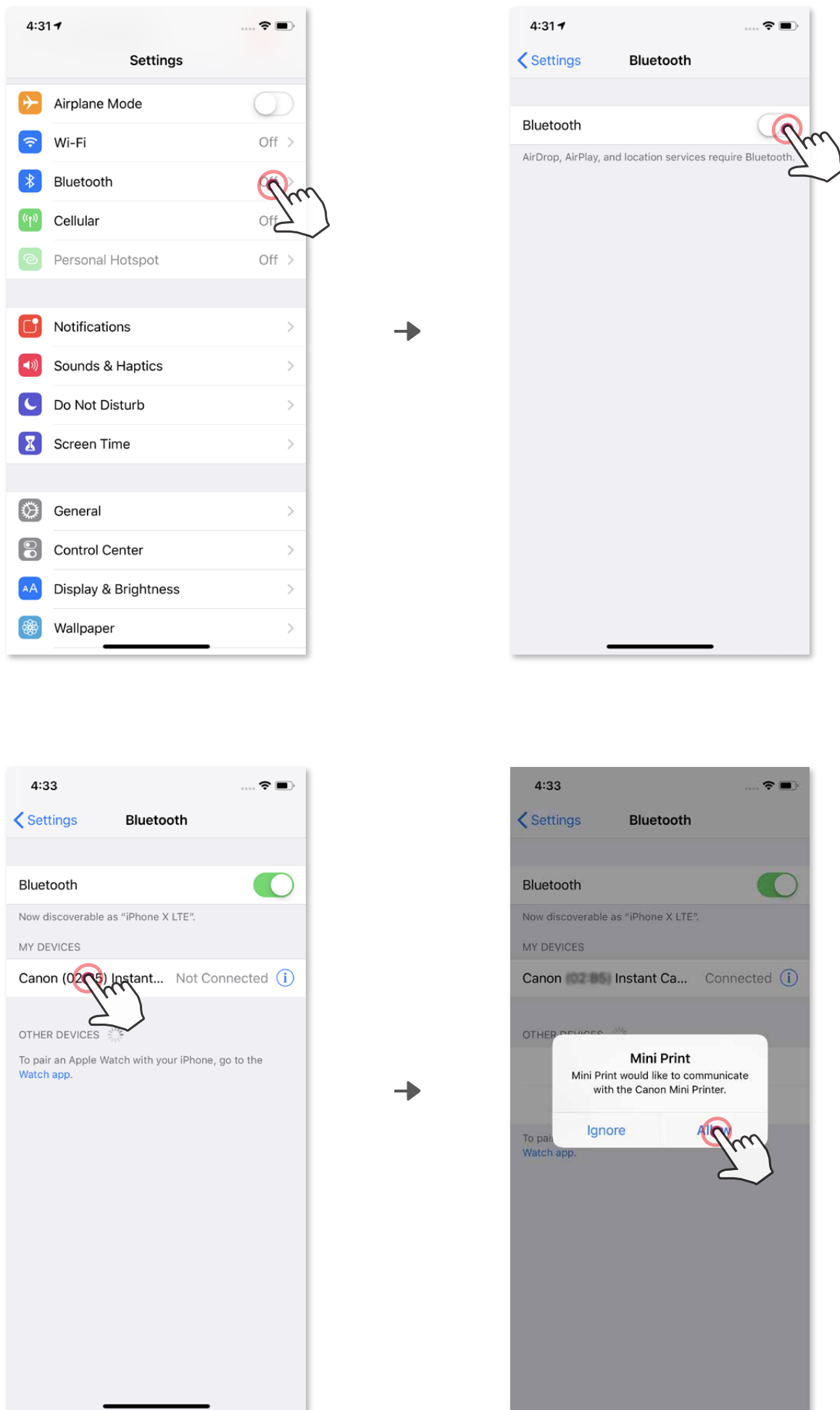

- ③ **OPTION A** - Add the printer to the app. Tap on the icon on the top right and choose your printer. The icon will change to indicate battery level when connected.

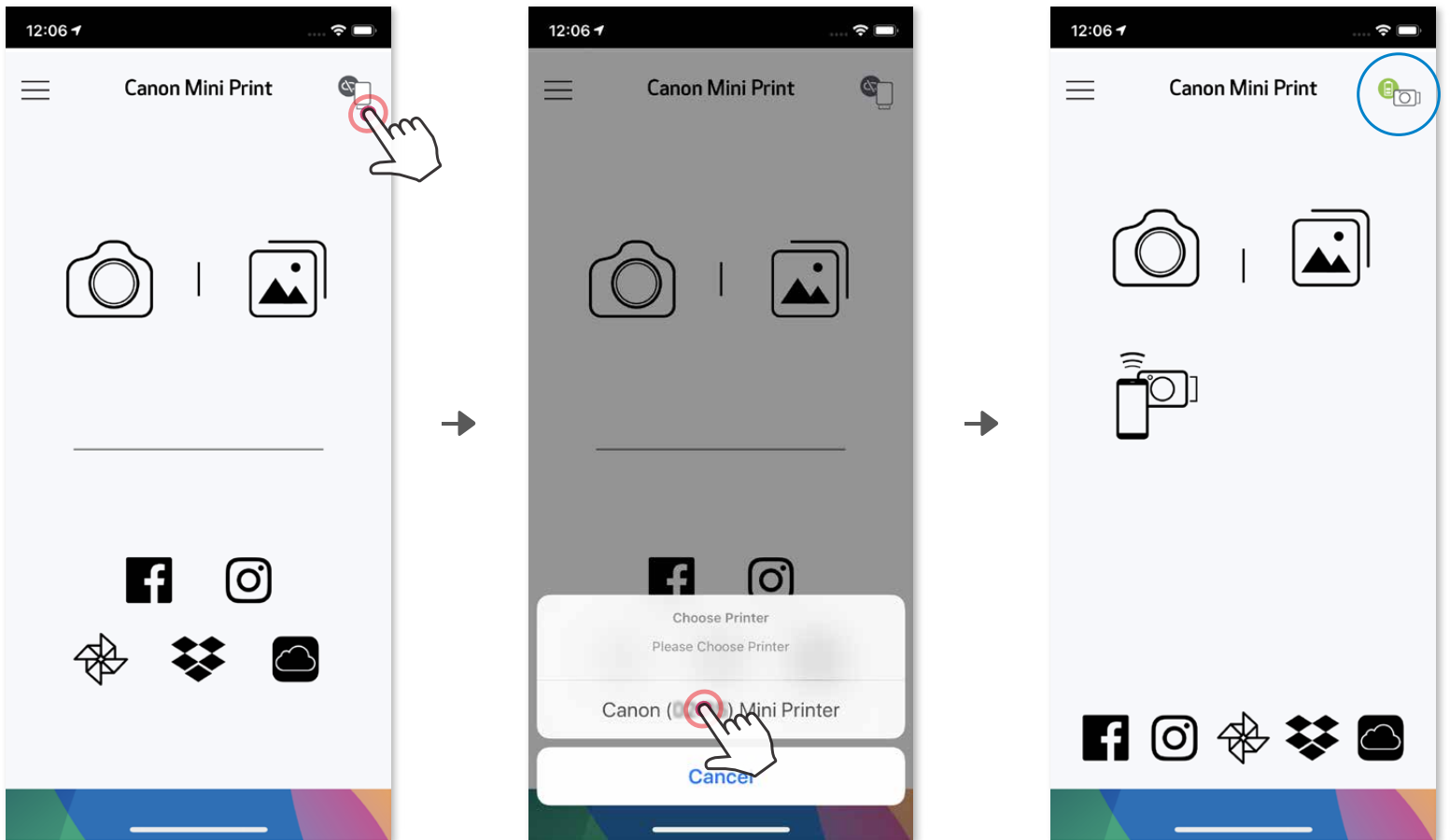

— OR —

- ③ **OPTION B** - Add the printer to the app. Go to "Settings" in the main menu, choose "Printers", then tap "Add Printer" and select your printer. Your printer will appear in the "Printers" list and the icon will change to indicate battery level when connected.

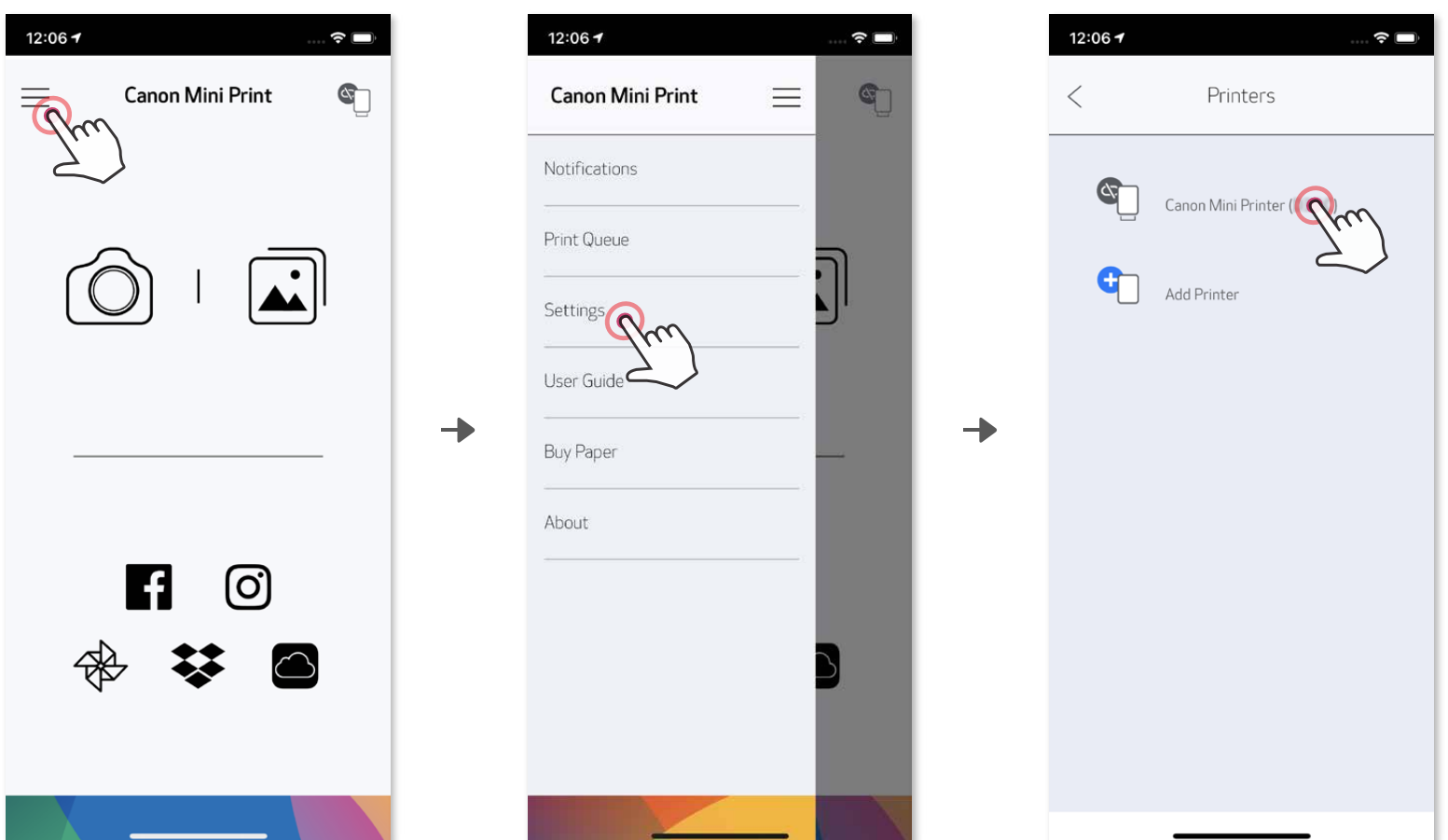

Android Pairing (with NFC)

- ① On your mobile device, ensure that NFC and Bluetooth® are enabled.
- ② Open the Canon Mini Print app.
- ③ Place your mobile device on top of the printer.
- ④ Follow the onscreen instructions to complete the pairing and connection for the first time. Or the printer will pair automatically with the mobile device.

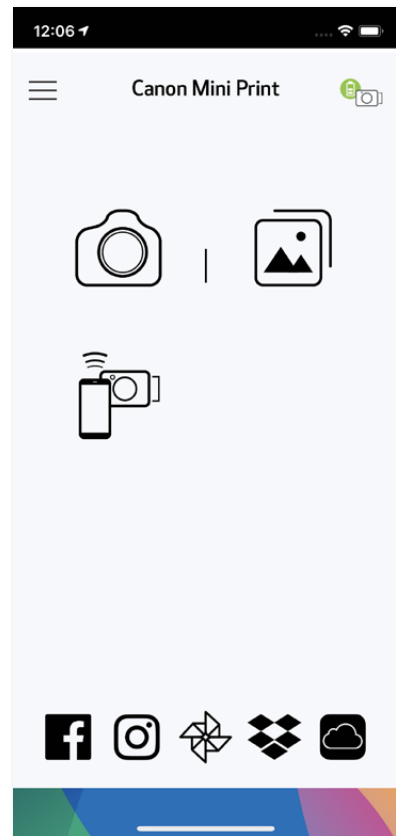
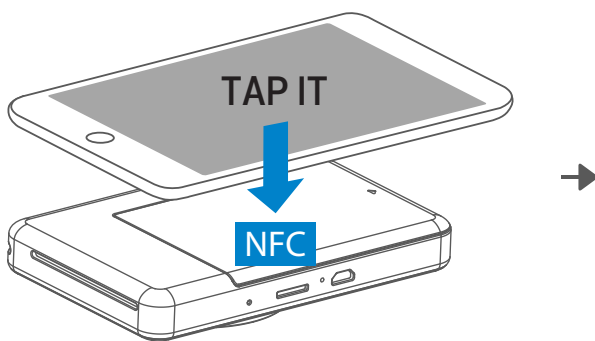

! NOTE

Printer Status Icon (shown in App)

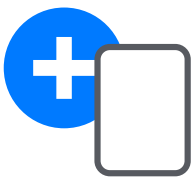

Add new printer



Printer not connected



Printer connected
(Battery status shown)

About Pairing

- One printer can be paired with only one iOS/Android device.
- One iOS/Android device can be connected to multiple printers.
To pair an additional printer, go to Printer Settings in the Main Menu and tap "Add Printer".
- Search for and pair a printer named "Canon (xx:xx) Instant Camera".
Match the last 4 digits of the MACnumber (xx:xx) on the label inside the printer.
- Bluetooth® searching and transferring may fail depending on the environment.
Check the Bluetooth® setting on your mobile device and try again.

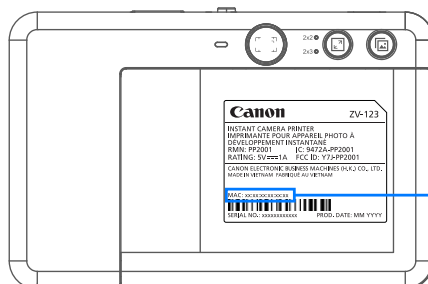
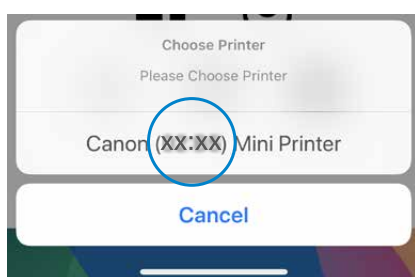

MAC: xx:xx:xx:xx:xx:xx

USER INTERFACE

HOME SCREEN

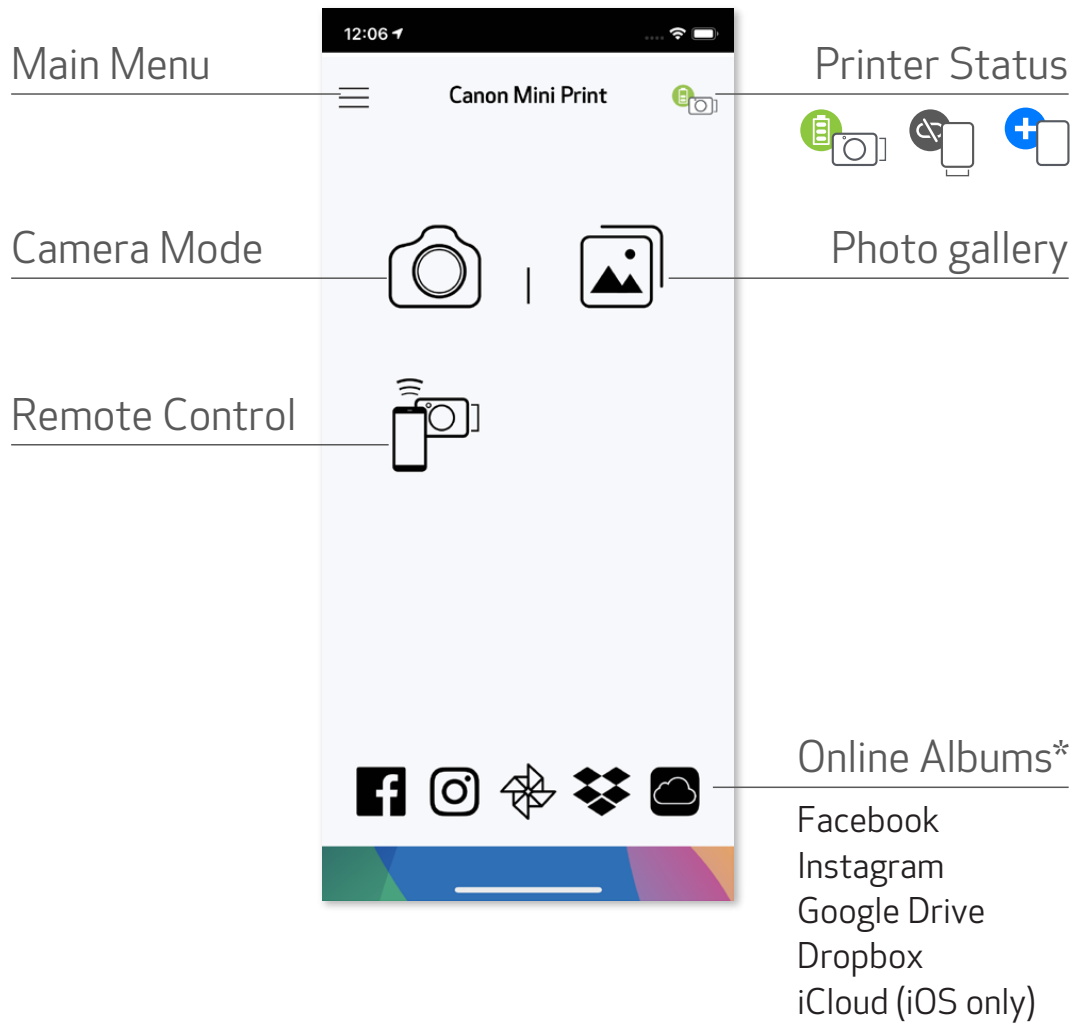

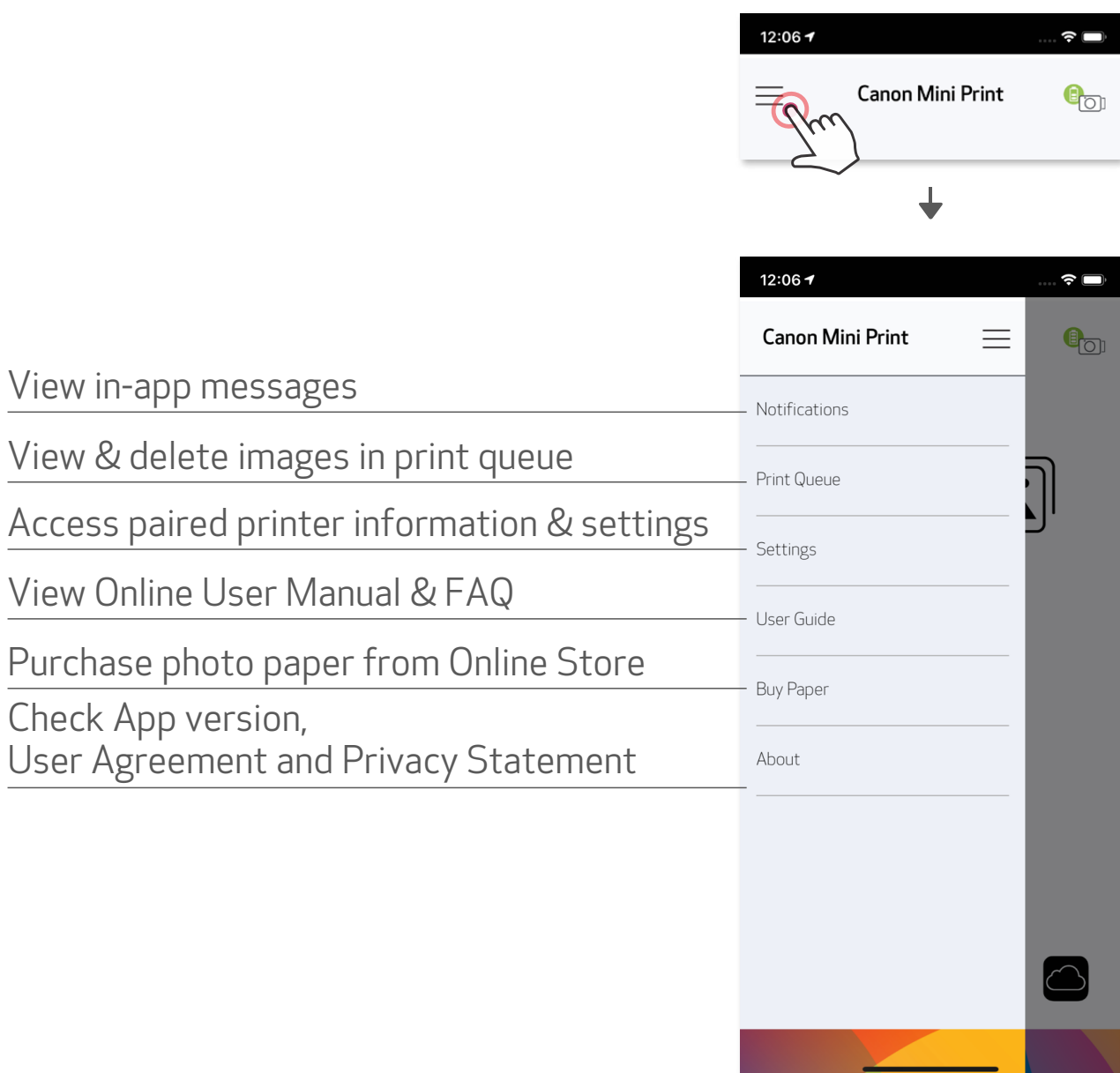

MAIN MENU



App experience, features, and available Online Albums may vary depending on your device and region.

* Internet Connection Required. Requires active social media or Cloud account(s) to use.

SMARTPHONE CAMERA MODE

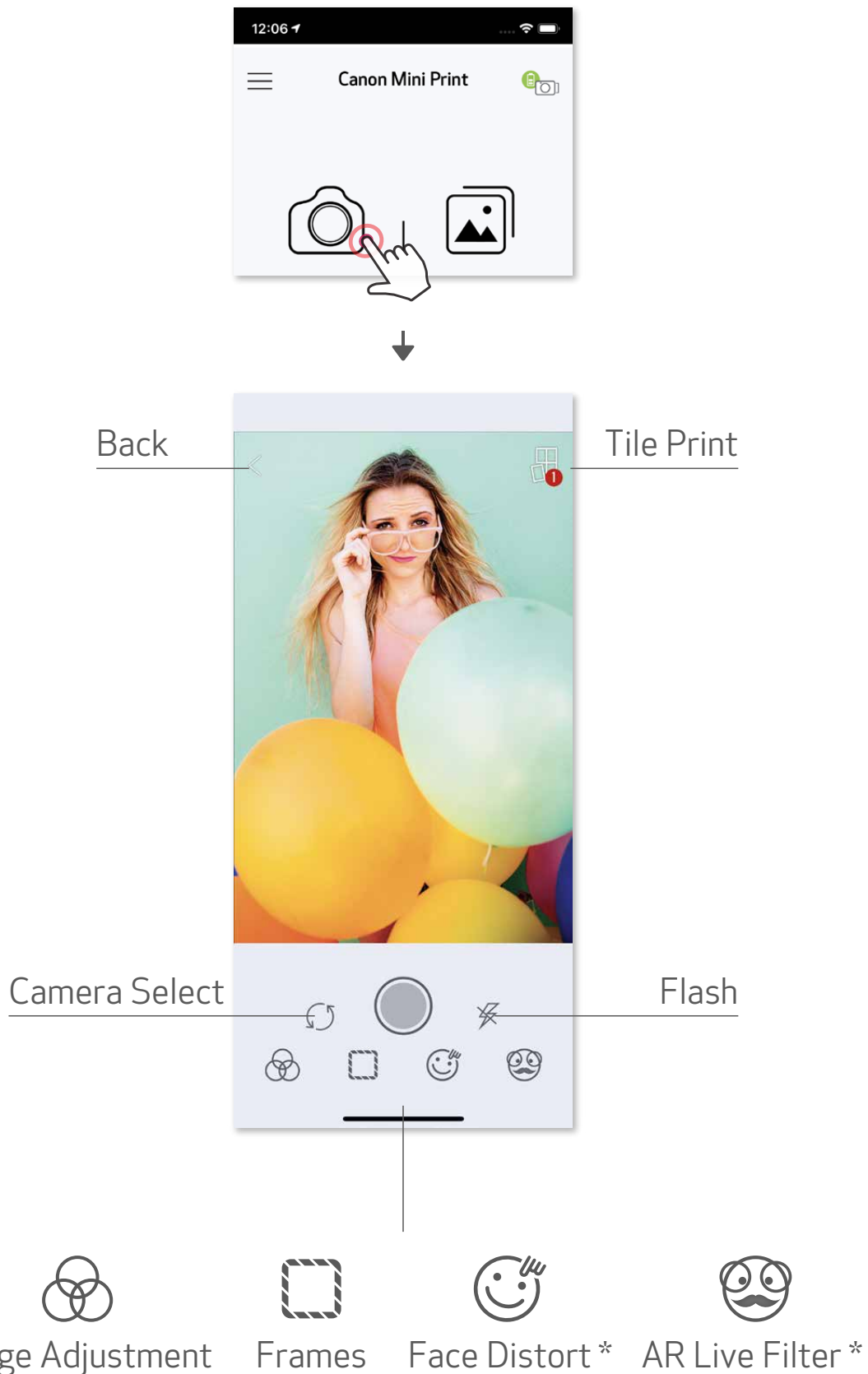

- ① On the Home Screen, tap  to take a photo with your smartphone camera. (Optional, tap on the icons at the bottom to take a photo with effects.)
- ② Once you've taken a photo, you can Print, Edit, Share, or Save.
- ③ To print, tap .



* Face detection in image required

PHOTO GALLERY

In the Photo Gallery you can browse photos in gallery view, by folders, or by calendar.

- ① On the Home Screen, Tap  to view the Photo Gallery.
- ② Once you've taken a photo, you can Print, Edit, Share, or Save.
- ③ To print, tap .

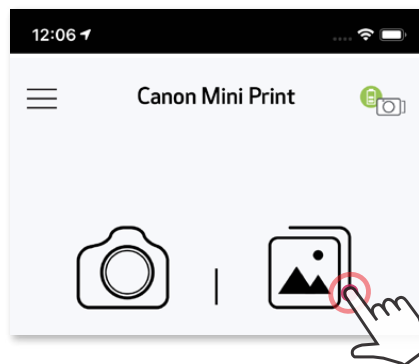

All Photos- Gallery

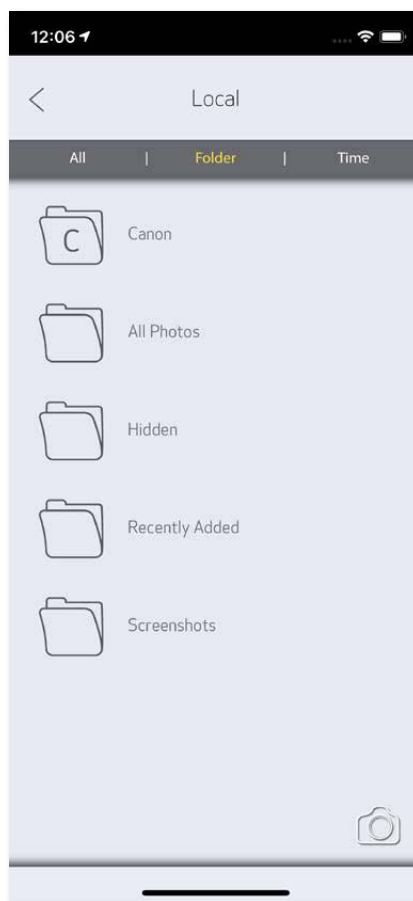

Folder View

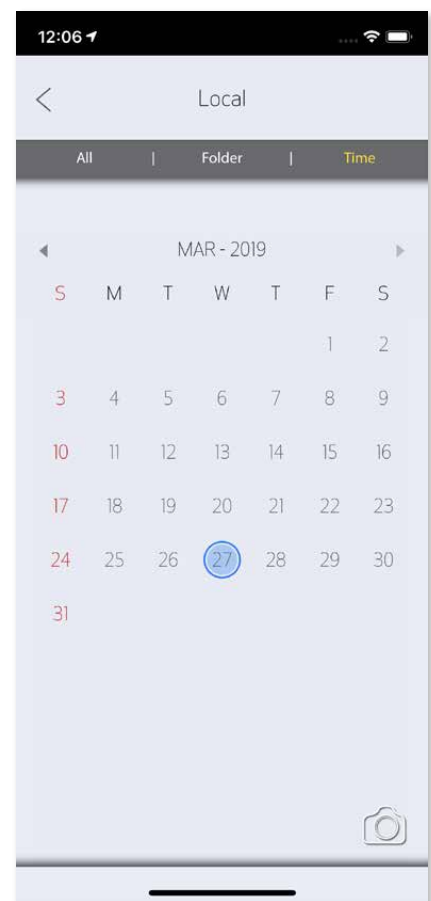

Calendar View

PRINT PHOTO

- ① When you are ready, tap  to print your photo. Make sure that the printer is on and paired/connected.



In the Print queue page, you can

- ① Tap  to delete photo in print queue
- ② Change the print order by tap and swipe the photo
- ③ Tap and stop printing a specific photo, a pause sign will be shown

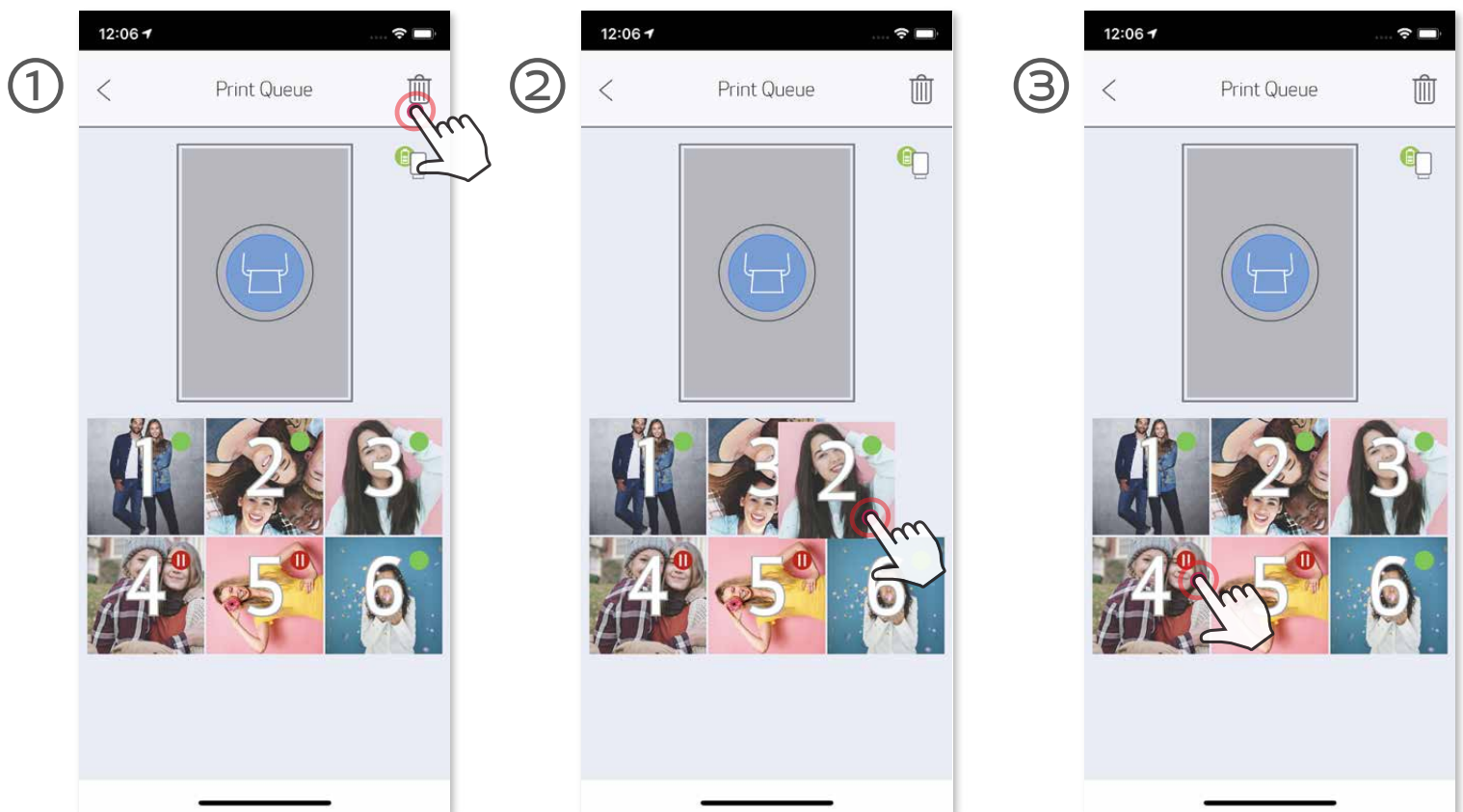

Note about Print Queue: Your image will be stored in the Print Queue if your printer is not on and connected when you send a print.

To release the print, simply turn your printer on and reconnect, you will be asked if you want to print the image in your queue.

To view or delete images in the queue, go to the Main Menu > Print Queue.

! NOTE

- The printed image may differ from the original image due to the "screen technology" used to display color on mobile device being different from the "print technology" used to print color on paper. (Thermal transfer printing).
- Do not pull the paper out by force during printing or paper jam.
- Do not open the top cover during printing. It may affect print quality.
- If the printer is vibrated or shaken, photo print quality may be affected.

EDIT PHOTO

You can customize your image with edits like filters, stickers, text, and more.

- ① Tap the icons on the bottom bar of your screen.
- ② Customize as you wish.
- ③ Don't forget to Save, Share, or Print your changes before you exit the screen.



Image
Adjustment

Frames

Text

Face Distort*



Stickers

Image Filter

Drawing

Brightness



Contrast

Saturation

RGB

Flip
(vertical)



Flip
(horizontal)

Rotate

* Face detection in image required

USING TILE PRINT

Use the Tile Print function to print a single photo onto multiple sheets so you can create a larger tiled print.

- ① When you're ready to print, tap on  and tap the tiled choice of 2 x 2 or 3 x 3 prints. (Lines will appear to show how your image will be split.)



- ② Tap  to print your tiles and then put them together to create a larger tiled print.





USING COLLAGE PRINT

Use the Collage function to print up to 6 photos on one 2x3 sheet.

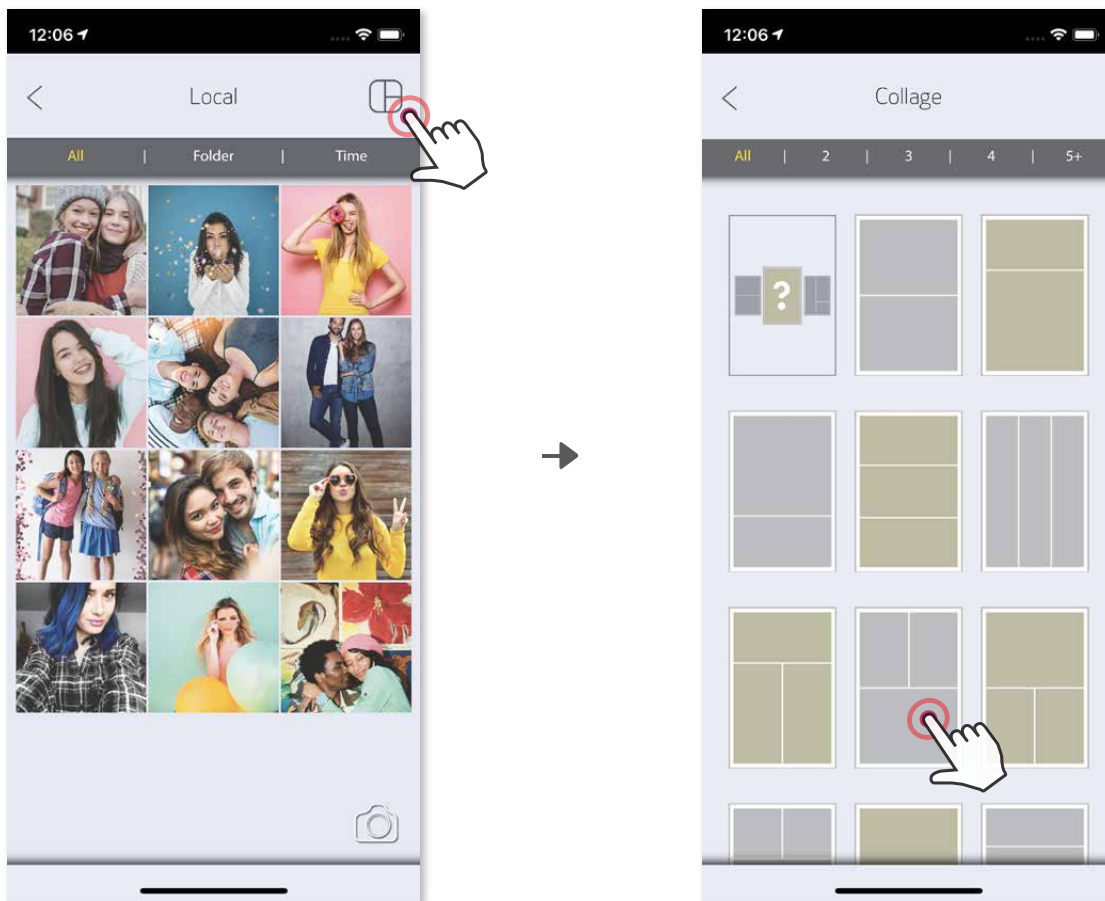
- ① Open your photos in the Photo Gallery or from Online Albums.
- ② Tap  to view the collage template choices and select one you want to use (you can choose from 2 to 6 photos in a template)



- ③ Check off the number of photos needed for the template and tap "selected"
- ④ Adjust the images in your collage as you'd like and then tap  to print,  to share or  to save.

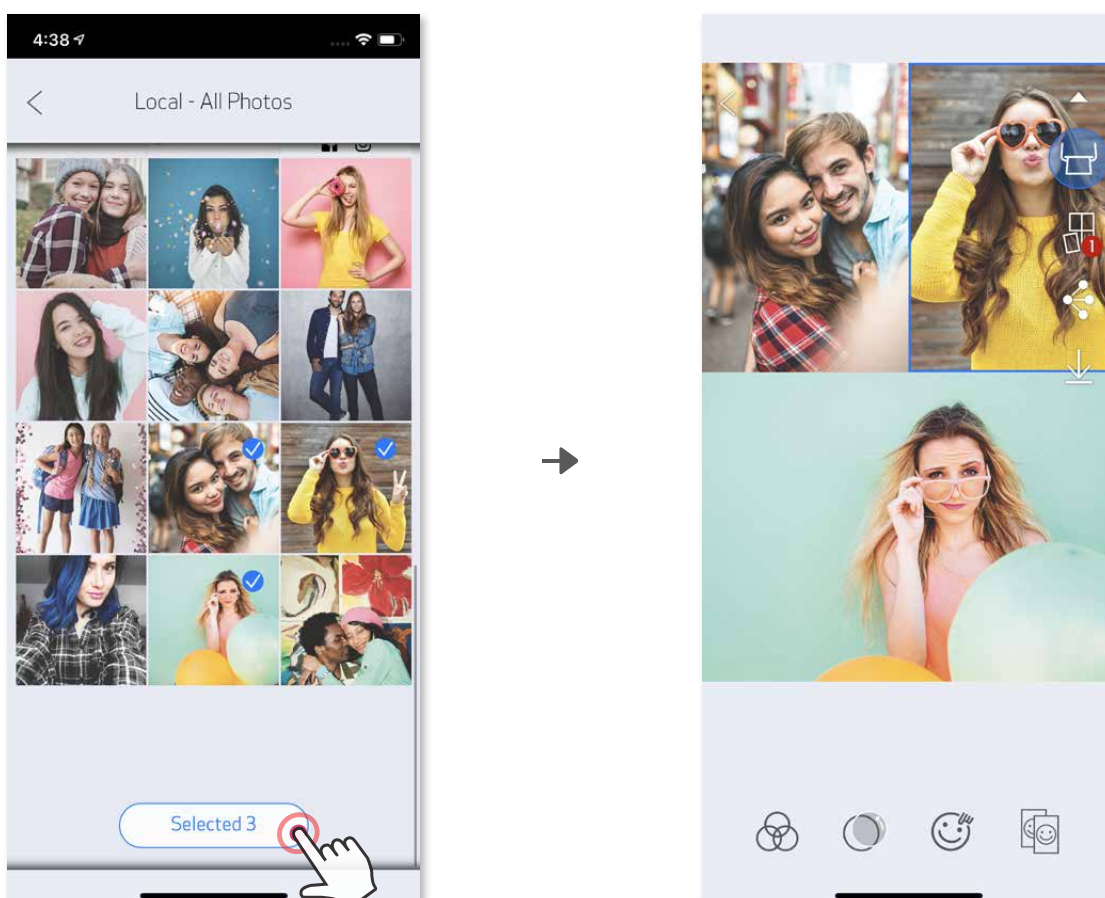

SHARE PHOTOS

You can easily share or save your images and edits.

① When you're ready, tap  to open the options on your device.

② Share with a listed app, or save to your device's photo storage.



Android

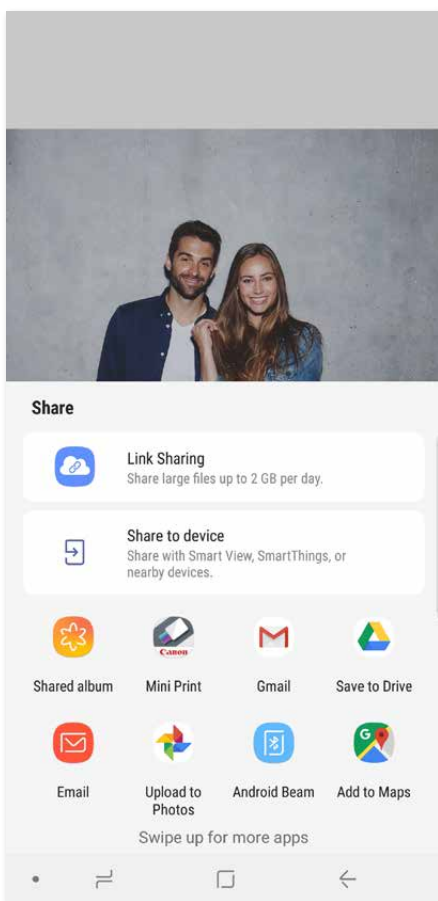

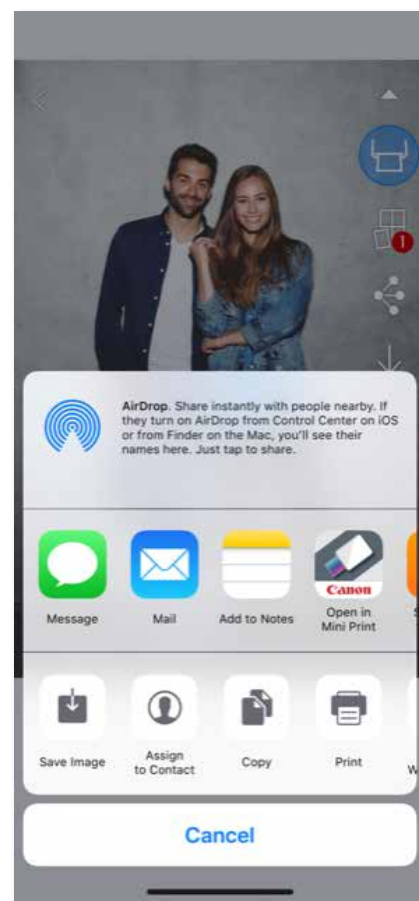

iOS



SAVE PHOTOS

You can easily save your images to the Canon folder in the app.

- ① When you're ready, tap  to save your image
- ② To view your saved images, tap , then tap "Folder", and then "Canon"

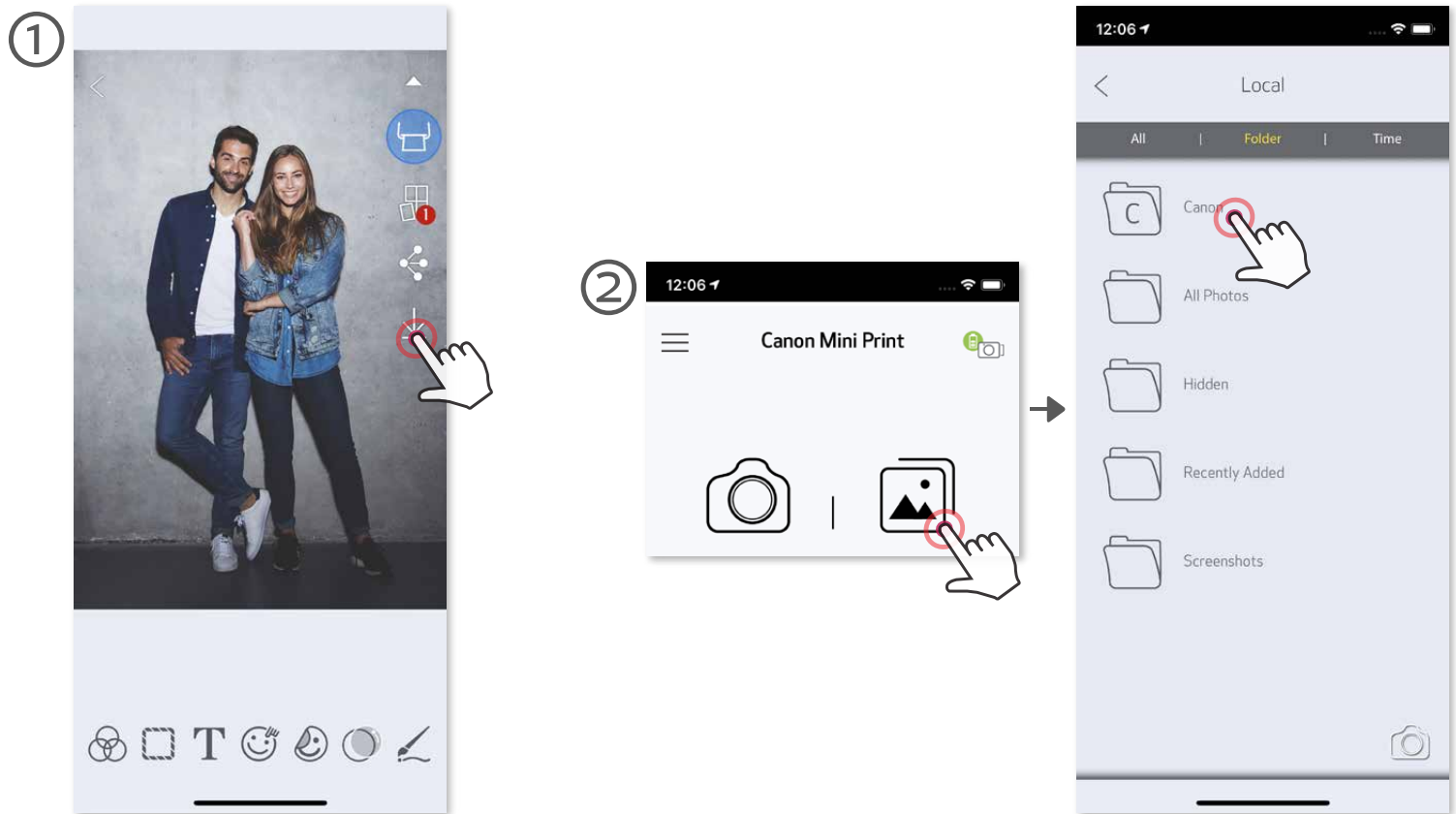

To delete a photo from the Canon Folder in the app, tap  to view the Photo Gallery.

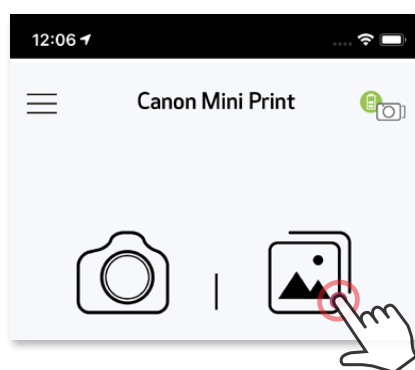

- ① Tap "Folder", then "Canon"
- ② Tap , then select the photo(s) you wish to delete permanently.

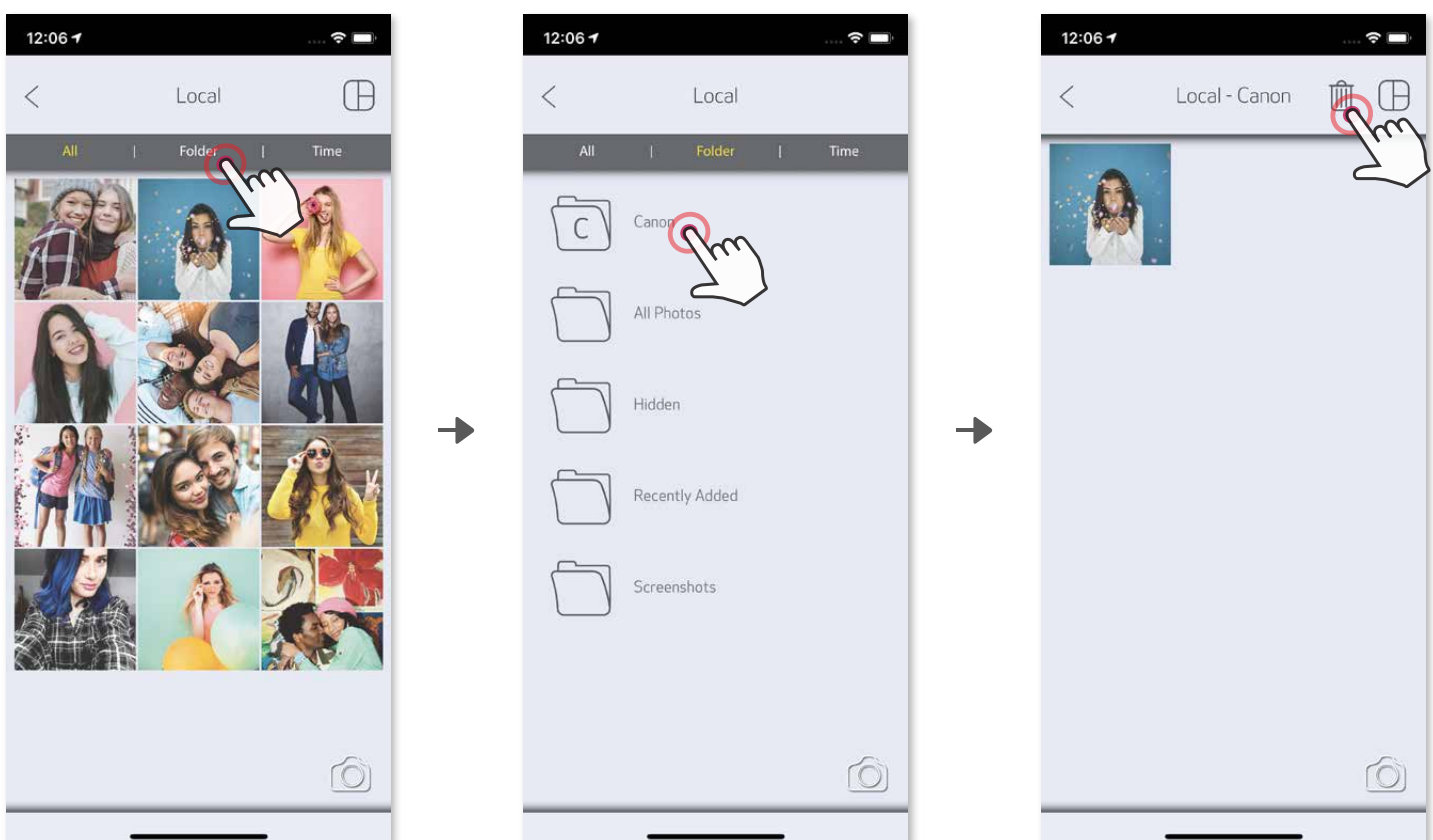

SEND TO MINI PRINT APP

Send a photo in your device's photo gallery or camera roll to the Canon Mini Print app

For Android

- ① Find a photo in your device Gallery and tap the share button.
- ② Tap the Mini Print Icon to send the photo to the app so you can edit and print.

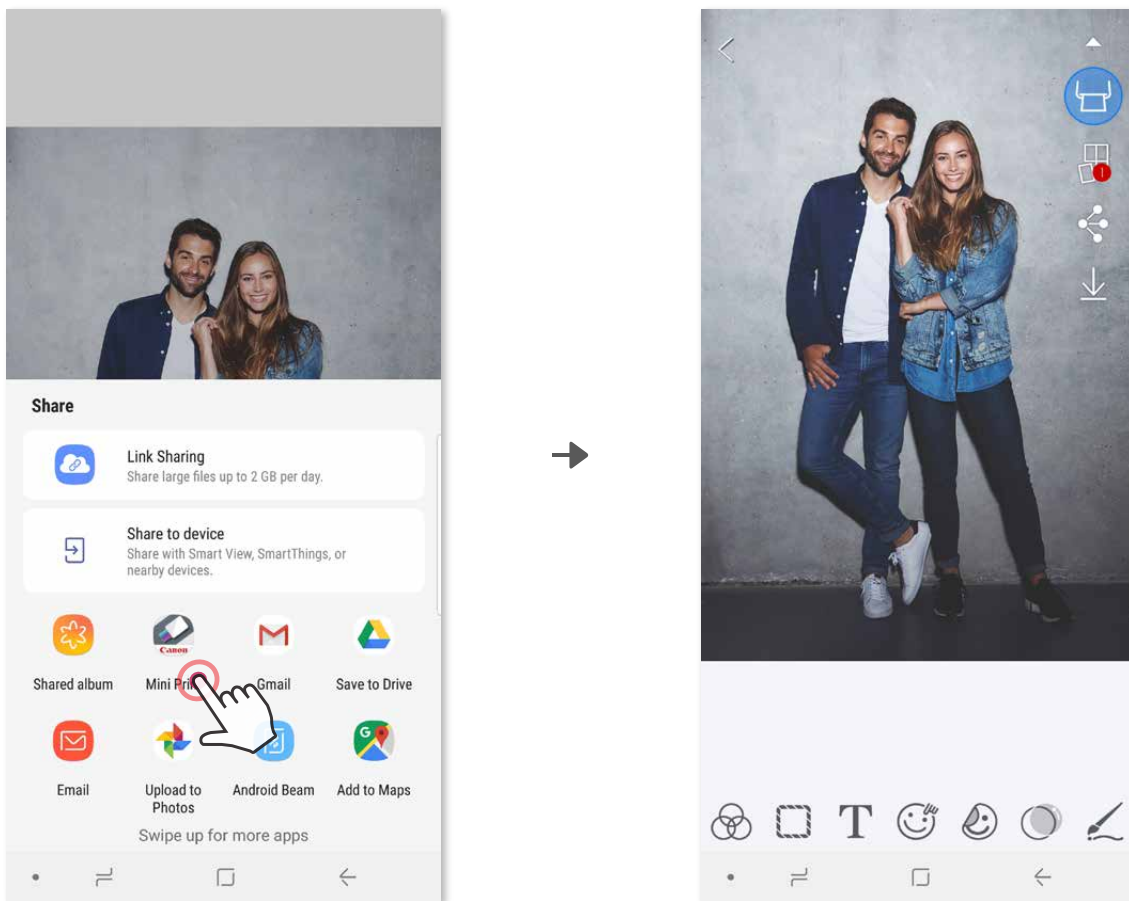

For iOS

- ① Find a photo in your device Gallery and tap the share button.
- ② **OPTION A** - Tap "Open in Mini Print" to send the photo to the app editing screen where you can edit and print.
- ③ **OPTION B** - Tap the "Print to Canon" to send the photo directly to the print queue.

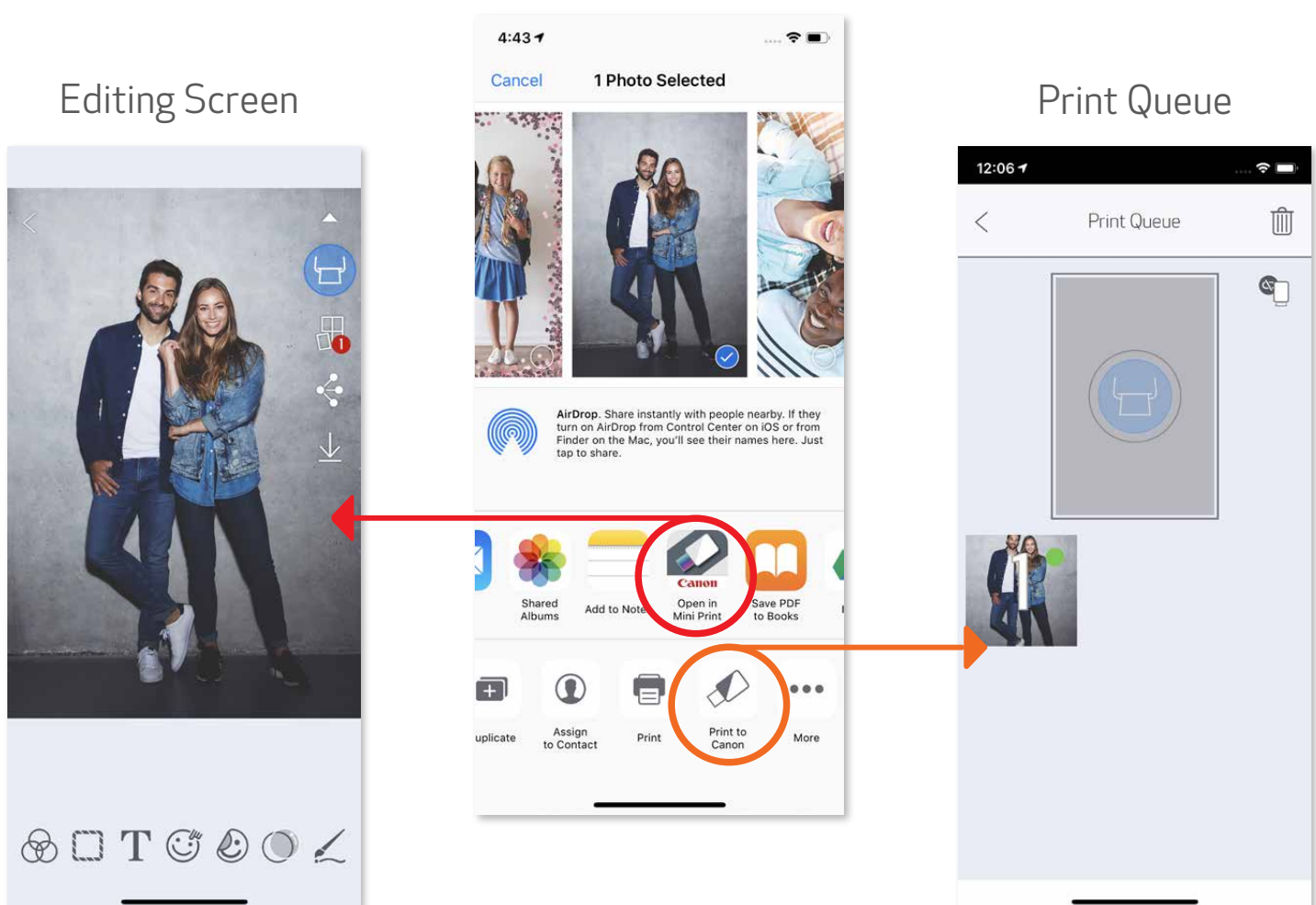

Canon

SMART SHEET, the ZINK Technology and ZINK Trademarks are owned by ZINK Holdings LLC. Used under license. Apple, the Apple logo, iPad, iPad Air, iPad Pro, and iPhone are trademarks of Apple Inc., registered in the United States and other countries. App Store is a service mark of Apple Inc. iOS is a trademark or registered trademark of Cisco in the United States and other countries and is used under license. Android, Google Play and the Google Play logo are trademarks of Google LLC. Bluetooth is a registered trademark of Bluetooth SIG. Wi-Fi is a registered trademark of the Wi-Fi Alliance. All other third-party product names, brand names and logos are trademarks of their respective owners.